

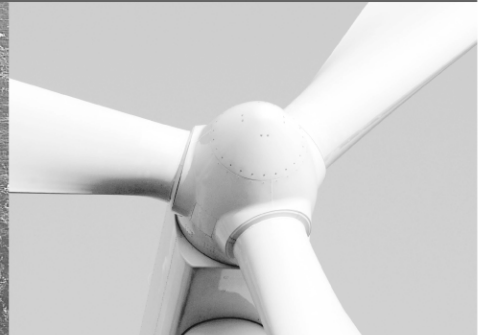

-power in control



INSTALLATION INSTRUCTIONS



Multi-transducer, MTR-3



DEIF A/S · Frisenborgvej 33 · DK-7800 Skive
Tel.: +45 9614 9614 · Fax: +45 9614 9615
info@deif.com · www.deif.com

Document no.: 4189300022C
SW version 3.0X.X or later

Table of contents

1. ABOUT THIS DOCUMENT	3
GENERAL PURPOSE.....	3
CONTENTS/OVERALL STRUCTURE.....	3
2. WARNINGS AND LEGAL INFORMATION.....	4
LEGAL INFORMATION AND RESPONSIBILITY.....	4
ELECTROSTATIC DISCHARGE AWARENESS	4
SAFETY ISSUES.....	4
DEFINITIONS	4
SAFETY WARNINGS AND INSTRUCTIONS FOR USE	5
WASTE	5
3. BASIC DESCRIPTION AND OPERATION OF THE MTR-3.....	6
INTRODUCTION.....	6
USER INFORMATION	7
DESCRIPTION OF THE PRODUCT	7
PURPOSE AND USE OF MEASURING TRANSDUCER.....	8
4. CONNECTION	10
INTRODUCTION.....	10
MOUNTING.....	10
CONNECTION OF INPUT/OUTPUT MODULES.....	12
COMMUNICATION CONNECTION	12
CONNECTION OF AUXILIARY POWER SUPPLY	14
5. SETTINGS	15
INTRODUCTION.....	15
M-SET SOFTWARE.....	15
SETTING PROCEDURE.....	16
GENERAL SETTINGS	16
CONNECTION	18
COMMUNICATION	18
SECURITY	19
ENERGY	19
ANALOGUE OUTPUTS.....	20
ALARMS.....	23
RESET OPERATIONS.....	23
6. MEASUREMENTS.....	24
INTRODUCTION.....	24
SUPPORTED MEASUREMENTS	24
AVAILABLE CONNECTIONS.....	24
EXPLANATION OF BASIC CONCEPTS	26
CALCULATION AND DISPLAY OF MEASUREMENTS	26
PRESENT VALUES.....	27
7. APPENDIX A: MODBUS PROTOCOL	29
MODBUS COMMUNICATION PROTOCOL.....	29
8. APPENDIX B: CALCULATIONS AND EQUATIONS	49
CALCULATIONS	49

1. About this document

General purpose

This document is the Installation Instructions for the Multi-configurable AC Transducer, the MTR-3. The general purpose of the document is to help the user with the first steps of installing and using the unit. It contains instructions for installations and use of the MTR-3.



Please make sure that you read this document before starting to work with the MTR-3. Failure to do this could result in human injury or damage to the equipment.

Contents/overall structure

This document is divided into chapters, and in order to make the structure simple and easy to use, each chapter will begin from the top of a new page.

2. Warnings and legal information

This chapter includes important information about general legal issues relevant in the handling of DEIF products. Furthermore, some overall safety precautions will be introduced and recommended. Finally, the highlighted notes and warnings, which will be used throughout this document, are presented.

Legal information and responsibility

DEIF takes no responsibility for installation or operation of the MTR-3. If there is any doubt regarding installation and use of the system in which the instrument is used for measuring or supervision, please contact the person or company responsible for the installation of such system.

The units are not to be opened by unauthorised personnel. If opened anyway, the warranty will be lost.

Electrostatic discharge awareness

Sufficient care must be taken to protect the terminals against static discharges during the installation. Once the unit is installed and connected, these precautions are no longer necessary.

Safety issues

Installing the unit implies work with dangerous currents and voltages. Therefore, the installation of the unit should only be carried out by authorised personnel who understand the risks involved in the working with live electrical equipment.



Be aware of the hazardous live currents and voltages. Do not touch any AC measurement inputs as this could lead to injury or death.

Definitions

Throughout this document, a number of notes with helpful user information will be presented. To ensure that these are noticed, they will be highlighted in order to separate them from the general text.

Note symbol



The notes provide general information which will be helpful for the reader to bear in mind.

Warnings



The warnings indicate a potentially dangerous situation which could result in death, personal injury or damaged equipment if certain guidelines are not followed.

Safety warnings and instructions for use

Check the following before switching on the device:

- Nominal voltage
- Proper connection of auxiliary supply
- Nominal frequency
- Voltage ratio and phase sequence
- Current transformer ratio and terminals' integrity
- Protection fuse – recommended maximal external fuse size is 6 A
- Proper connection of I/O modules



The secondary output of the current transformer should be short-circuited before connecting the transducer.

Waste

It is forbidden to deposit electrical and electronic equipment as municipal waste. The manufacturer or provider shall take waste electrical and electronic equipment free of charge. The complete procedure after lifetime should comply with the Directive EZ 2002/96/EG about restriction on the use of certain hazardous substances in electrical and electronic equipment or a corresponding Url 118/04.

3. Basic description and operation of the MTR-3

Introduction





What is in the delivery?

The consignment includes:

- Multi transducer MTR-3
- Label for I/O functionality description
- Quick Start Guide

Description of symbols

In different chapters or tables, different symbols may appear in the installation instructions. According to the position of symbols, they have different meanings.

	Double insulation in compliance with the SIST EN 61010-1 standard.
	Functional ground potential. Note: this symbol is also used for marking a terminal for protective ground potential if it is used as a part of connection terminal or auxiliary supply terminals.
	Compliance of the product with directive 2002/96/EC, as first priority, the prevention of waste electrical and electronic equipment (WEEE), and in addition, the reuse, recycling and other forms of recovery of such wastes so as to reduce the disposal of waste. It also seeks to improve the environmental performance of all operators involved in the life cycle of electrical and electronic equipment.
	Compliance of the product with European CE directives.
Subchapter	Symbols next to the subchapters indicate accessibility of functions described. Accessibility of functions is indicated with the following symbols:  Function accessible via communication (M-Set software)
Tables	Supported functions and measurements are listed in tables. Symbols in tables indicate support of enabled functions. Additionally, a legend is placed the below table of used symbols. The meaning of symbols is: <ul style="list-style-type: none"> • Function is supported × Function is not supported ○ Symbol meaning varies and is described in the legend below the table

User information

For unknown technical terms, please refer to the below glossary.

Glossary

Term	Explanation
RMS	Root Mean Square value
Modbus	Industrial protocol for data transmission
M-Set	Software for MTR-3
AC	Alternating voltage and current
PA total	Angle calculated from total active and apparent power
PA1, PA2, PA3	Angle between fundamental phase voltage and phase current
PF	Power factor
THD	Total Harmonic Distortion
MD	Measurement of average values in time interval
Hand-over place	Connection spot of consumer installation in public network
M_v – Sample factor	Defines a number of periods for measuring calculation on the basis of measured frequency
M_p – Average interval	Defines frequency of refreshing displayed measurements on the basis of a sample factor
Hysteresis expressed as percentage [%]	Percentage specifies increase or decrease of a measurement from a certain limit after exceeding it.

Description of the product

The measuring transducer is intended for measuring, analysing and monitoring single-phase or three-phase electrical power network. It measures RMS value by means of fast sampling of voltage and current signals, which makes the instrument suitable for acquisition of transient events. A built-in micro controller calculates measurements (voltage, current, frequency, energy, power, power factor, THD phase angles, etc.) from the measured signals.

Appearance

The measuring transducer can differ from yours depending on the type and functionality.

- 1 Communication ports
- 2 Outputs
- 3 Auxiliary supply
- 4 Voltage inputs
- 5 Current inputs
- 6 Power ON LED

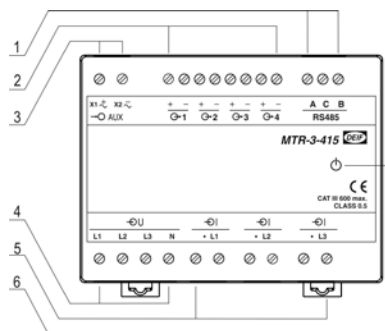

Communication ports and LED indicators

Serial communication can be connected by using screw-in connector (RS485). A USB can be connected through a USB-mini type connector at the bottom of the transducer.

LED indicator is intended for POWER ON signalling (red LED).



The USB communication port is NOT galvanically insulated and can be used ONLY UN-connected to aux. supply and power inputs!

Universal auxiliary supply

Auxiliary supply is connected by two screw-in connectors. For safety purposes, it is important that all wires are firmly fastened. Auxiliary supply is wide range (24V DC-300V DC; 40V AC-276V AC).

Voltage inputs

Each voltage input is connected to a measuring circuit through an input resistor chain (3.3 M Ω per phase). Maximum value of input voltage is 600 V_{L-N} (1000 V_{L-L}).

Current inputs

Each current input is connected to a measuring circuit through a current transformer (0.01 Ω per phase). Maximum allowed thermal value of input current is 15 A (cont.).

Purpose and use of measuring transducer

The instrument is used for monitoring and measuring electric quantities of three-phase electrical power distribution system. The meter is provided with 32 programme-adjustable alarms and communication. With the RS485 and USB communication, the transducer can be configured and by RS485 also measurements can be read. The transducer also functions as an energy counter (up to four energy counters).

Supported measurements

Basic measurements	
Phase	Voltage U_1, U_2, U_3 and U^-
	Current I_1, I_2, I_3, I_n, I_t and I_a
	Active power $P_1, P_2, P_3,$ and P_t
	Reactive power $Q_1, Q_2, Q_3,$ and Q_t
	Apparent power $S_1, S_2, S_3,$ and S_t
	Power factor PF_1, PF_2, PF_3 and PF^-
	Power angle $\varphi_1, \varphi_2, \varphi_3$ and φ^-
	THD of phase voltage U_{r1}, U_{r2} and U_{r3}
	THD of power angle I_1, I_2 and I_3
Phase-to-phase	Phase-to-phase voltage U_{12}, U_{23}, U_{31}
	Average phase-to-phase voltage U_{ff}
	Phase-to-phase angle $\varphi_{12}, \varphi_{23}, \varphi_{31}$
	THD of phase-to-phase voltage
Energy	Counter 1
	Counter 2
	Counter 3
	Counter 4
	Active tariff
Other measurements	
MD values	Phase current I_1, I_2, I_3
	Active power P (Positive)
	Active power P (Negative)
	Reactive power Q - L
	Reactive power Q - C
	Apparent power S
Other measurements	
Measurements	Frequency
	Internal temperature

4. Connection

Introduction

This chapter deals with the instructions for connection of the measuring transducer. Both the use and connection of the device includes handling with dangerous currents and voltages. Only qualified persons should therefore perform connection. DEIF does not take any responsibility regarding the use and connection. If any doubt occurs regarding connection and use in the system, please contact the person or company responsible for such installations.

Before use: check voltages and phase rotation, supply voltage and nominal frequency.

Check protective fuse rating (the recommended maximum rating of the external protective fuse for this equipment is 6 A - Red Spot type or equivalent).



Wrong or incomplete connection of supply, measurement or other terminals may cause malfunction or damage the device.



After connection, settings are performed via communication (connection mode, current and voltage transformers ratio...).

Mounting

The MTR-3 is designed for DIN rail mounting. It should be mounted on a 35 mm DIN rail by means of three plastic fasteners. Before installation, fasteners should be in open position (pulled). When the device is in place, lock (push) the fasteners to closed position.

Electric connection

Voltage inputs of the measuring transducer can be connected directly to a low-voltage network or via an appropriate voltage measuring transformer to a medium or high voltage network.

Current inputs of the measuring transducer can be connected directly to a low-voltage network or via a corresponding current transformer.

Choose the corresponding connection from the following figures and connect the corresponding voltages and currents. Information on electrical characteristics is given in the data sheet.

System/connection

Terminal assignment

Connection 1b (1W)
Single-phase connection

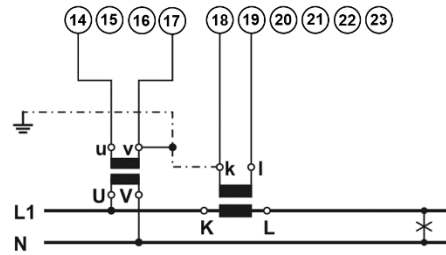

Connection 3b (1W3)
Three-phase – three-wire connection with balanced load

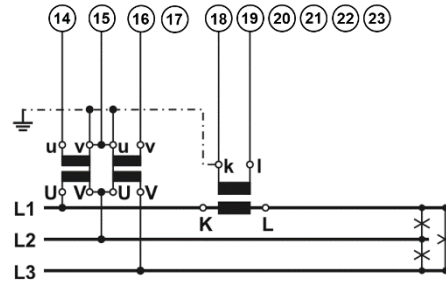

Connection 3u (2W3u)
Three-phase – three-wire connection with unbalanced load

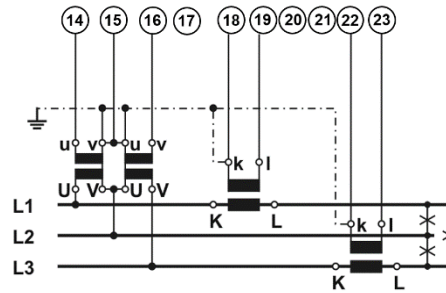

Direct connection 3u (2W3u)
Three-phase, three-wire direct connection

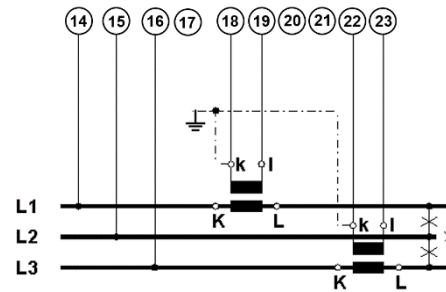

Connection 4b (1W4)
Three-phase – four-wire connection with balanced load

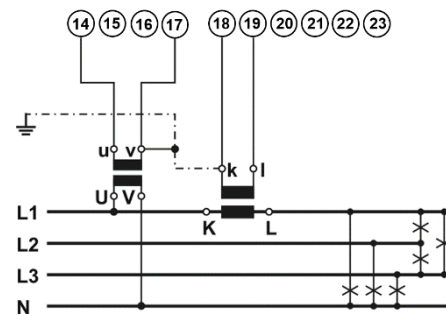

Connection 4u (3W4)

Three-phase – four-wire connection with unbalanced load

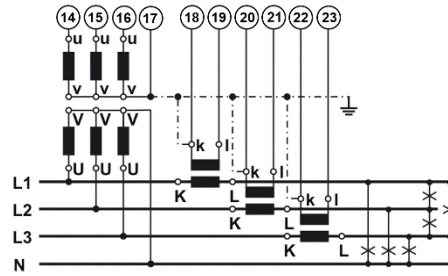
**Connection of input/output modules**

Check the module features that are specified on the label, before connecting module contacts. Wrong connection may cause damage or destruction of module and/or device.

Connect the module contacts as specified on the label. Examples of labels are given below and describe modules built in the device.

I/O 1			
Analogue output			
0...+/-20 mA	+ 3		
0...+/-10 V	- 4		

Analogue output module with analogue output, proportional to measured quantities. The outputs may be either short- or open-circuited. They are electrically insulated from each other and from all other circuits. (Example of analogue output 1).

I/O 1			
Fast analogue output			
0...+/-20 mA	+ 3		
0...+/-10 V	- 4		

Fast analogue output module with analogue output, proportional to measured quantities. The outputs may be either short- or open-circuited. They are electrically insulated from each other and from all other circuits. (Example of analogue output 1).

Communication connection

The MTR-3 is equipped with one standard serial (RS485) communication port and one service communication port (USB).



The USB communication port is NOT galvanically insulated and can be used ONLY UN-connected to aux. supply and power inputs!

Connect the communication line by means of the corresponding terminals. Connection information is stated on the instrument label. Connector terminals are marked on the label on the upper side of the instrument.

The USB connector is positioned on the bottom side of the instrument under removable plastic cover. For driver installation, the below note. The instrument will establish USB connection with the PC approx. 5 seconds after physical connection to the USB port.

More detailed information about communication specifications is available in the data sheet.

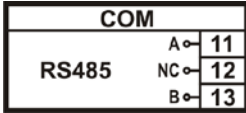
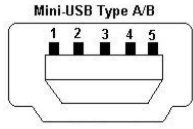
	Serial communication port (RS485)
	SERVICE communication port (USB)

RS485

RS485 communication is intended for connection of devices to network where several instruments with RS485 communication are connected to a common communication interface.

It is necessary to provide the corresponding connection of individual terminals of the screw terminal connector (see the table below).

USB

USB communication serves as a fast peer-to-terminal data link. The instrument is detected by host as a USB 2.0 compatible device. The USB connection is provided through a USB standard type mini B connector.



When the MTR-3 is connected to a PC through USB communication for the first time, a user is prompted to install a driver. The driver is provided when downloading M-Set. The M-Set software can be downloaded at www.deif.com. When the driver is installed, the USB is redirected to a serial port, which should be selected when using M-Set software.

Survey of communication connections

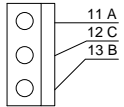
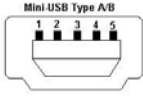
Connector	Terminals	Position	RS485
SCREW TERMINAL		11	A
		12	NC
		13	B
USB-mini B		Standard USB 2.0 compatible cable recommended (type mini B plug)	

Connection of auxiliary power supply

The MTR-3 multi transducer has universal (AC/DC) auxiliary power supply. Information on electric consumption is given in the data sheet. Auxiliary supply is connected through a screw terminal connector.

<table border="1"> <thead> <tr> <th colspan="2">AUX</th> </tr> </thead> <tbody> <tr> <td>24...300 V DC</td> <td>1</td> </tr> <tr> <td>40...276 V AC \sim</td> <td>2</td> </tr> <tr> <td>45...65 Hz \sim</td> <td></td> </tr> <tr> <td>< 8 VA</td> <td></td> </tr> </tbody> </table>	AUX		24...300 V DC	1	40...276 V AC \sim	2	45...65 Hz \sim		< 8 VA		Connection of universal power supply to terminals 1 and 2.
AUX											
24...300 V DC	1										
40...276 V AC \sim	2										
45...65 Hz \sim											
< 8 VA											



For safety purposes, it is important that both wires (Line and Neutral) are firmly connected.

5. Settings

Introduction

Instrument settings can be remotely modified with communication (RS485 or USB) and M-Set software when connected to a PC.

M-Set software

M-Set is a software tool for complete monitoring of measuring instruments, connected to a PC via serial or USB communication. A user-friendly interface consists of four segments: device management, instrument settings, real-time measurements and software upgrading.

Device management

Select the instrument in a favourite's line. Use the network explorer to set and explore the device's network. Communication parameters of all devices and their addresses in the network can be easily set.

Instrument settings

Multi register edit technology assures a simple modification of settings that are organised in a tree structure. Besides transferring settings into the instrument, storing and reading from the setting files are also available.

Real-time measurements

All supported measurements can be captured in real time in a table form. For further processing of the results of measurements, copying via a clipboard into standard Windows formats is supported.

Software upgrading

Always use the latest version of software, both M-Set and software in the instrument. The programme automatically informs you on available upgrades that can be transferred from the website and used for upgrading.



More information about the M-Set software can be found in the M-Set help system.

M-Set user interface PC

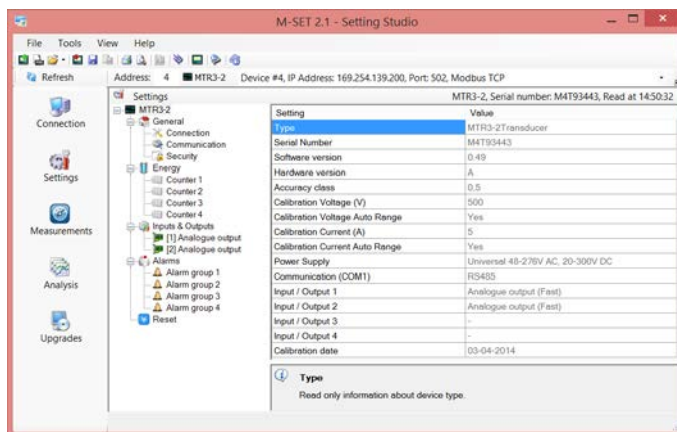

You can download freeware M-Set from www.deif.com.

Setting procedure

In order to modify instrument settings with M-Set, current parameters must be loaded first. Instrument settings can be acquired via a communication link (serial or USB) or can be loaded off-line from a file on a local disk. Settings are displayed in the M-Set setting window - the left part displays a hierarchical tree structure of settings, the right part displays parameter values of the chosen setting group.

General settings

General settings are essential for the transducer. They are divided into four additional sublevels (Connection, Communication, Display and Security).

Description and location PC

Two parameters that are intended for easier recognition of a certain unit. They are especially used for identification of the device or location on which measurements are performed.

Average interval PC

The averaging interval defines the refresh rate of measurements on communication and remote display.

Temperature unit PC

Choose a unit for temperature display.

Maximum demand calculation (MD mode) PC

The instrument provides maximum demand values using thermal function. A thermal function assures exponent thermal characteristic based on simulation of bimetal meters. Maximum values and time of their occurrence are stored in the device. A time constant (t. c.) can be set from 1 to 255 minutes and is 6 times the thermal time constant (t. c. = 6 * thermal time constant).

Example:

Mode: thermal function

Time constant: 8 min.

Current MD and maximal MD: reset at 0 min.

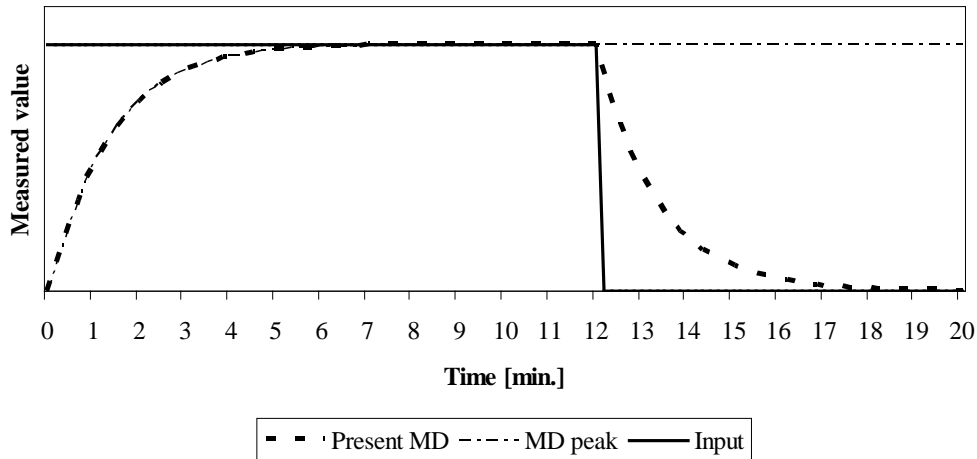
Thermal function**Starting current for PF and PA (mA) ^{PC}**

At all measuring inputs, noise is usually present. It is constant, and its influence on the accuracy is increased by decreasing measuring signals. It is present also when measuring signals are not connected, and it occurs at all further calculations as very sporadic measurements. By setting a common starting current, a limit of input signal is defined where measurements and all other calculations are still performed.

Starting current for all powers (mA) ^{PC}

Noise is limited with a starting current also at measurements and calculations of powers.

Minimum synchronisation voltage ^{PC}

If all phase voltages are smaller than this (noise limit) setting, the instrument uses current inputs for synchronisation. If also all phase currents are smaller than **Starting current for PF and PA** setting, synchronisation is not possible and frequency displayed is 0.

Reactive power and energy calculation ^{PC}

Two different principles of reactive power and energy calculation are used:

Standard method:

With this method, a reactive power and energy is calculated, based on the assumption that all power (energy), which is not active, is reactive.

$$Q^2 = S^2 - P^2$$

This also means that all higher harmonics will be measured as reactive power (energy).

Delayed current method:

With this method, reactive power (energy) is calculated by multiplication of voltage samples and delayed current samples (see chapter 8, "Appendix B: Calculations and equations" on page 36):

$$Q = U \times I|_{+90^\circ}$$

With this method, reactive power (energy) only represents the true reactive component of apparent power (energy).

Connection



Settings of connections must reflect actual state, otherwise measurements are not valid.

Connection PC

When connection is selected, load connection and the supported measurements are defined (see chapter 6, “Measurements” regarding connection mode, on page 23).

Setting of current and voltage ratios PC

Before setting current and voltage ratios, it is necessary to be familiar with the conditions in which the device is to be used. All other measurements and calculations depend on these settings. Up to five decimal places can be set.

Settings range	VT primary	VT secondary	CT primary	CT secondary
Maximum value	1638.3 kV	13383 V	1638.3 kA	13383 A
Minimum value	0.1 V	1 mV	0.1 A	1 mA

Used voltage and current range PC

Setting of the range is connected with all settings of alarms, analogue outputs and a display (calculation) of energy and measurements recording, where 100% represents 500 V 5 A. In case of subsequent change of the range, alarms settings must be correspondingly changed, as well.

Nominal frequency PC

A valid frequency measurement is within the range of nominal frequency ± 32 Hz. This setting is used for alarms.

Energy flow direction PC

This setting allows manual change of energy flow direction (IMPORT to EXPORT or vice versa) in the readings tab. It has no influence on readings sent by communication.

CT connection PC

If this setting is set to REVERSED, it has the same influence as if CTs would be reversely connected. All power readings will also change their sign.

Communication

Serial Communication PC

Define parameters that are important for the operation in the RS485 network. Factory settings of communication are #33\115200,n,8,2 (address 1 to 247\baud rate 2400 to 115200 b/s, parity, data bits, stop bit).

Modbus table: with this setting, a Modbus table for measurements and settings is defined. Modbus addresses for measurements and settings can be compatible with the previous family of transducers (MTR-2). For a more detailed description, see chapter 7, “Appendix A: Modbus protocol”, on page 28.

USB Communication PC

For description of all settings **see Serial Communication, appendix A**. For driver installation, see the note on page 13. The instrument will establish a USB connection with the PC approx. 5 seconds after physical connection to the USB port.

Security

Parameter settings are divided into three groups regarding security level:

1. At the first level (PL1), settings of a real time clock can be changed, and energy meters and MD can be reset.
2. At the second level (PL2), the access to all data that are protected with the first level (PL1) and setting of all other parameters in the »SETTINGS« menu is available.
3. A backup password (BP) is used if passwords at levels 1 (PL1) and 2 (PL2) have been forgotten, and it is different for each device (depending on a serial number of the meter). The BP password is available in the support department at DEIF, and is entered instead of the password PL1 or/and PL2. Do not forget to state the meter serial number when contacting the personnel at DEIF.

User information



A serial number of device is stated on the label and also accessible with the M-Set software.

Password setting

A password consists of four letters taken from the British alphabet from A to Z. When setting a password, only the letter being set is visible while the others are covered with *.

Two passwords (PL1, PL2) and the time of automatic activation could be set.

Password modification

A password can be modified; however, only that password can be modified to which the access is unlocked at the moment.

Password disabling

A password is disabled by setting the "AAAA" password.



A factory-set password is "AAAA" at both access levels (L1 and L2). This password does not limit access.

Energy



After modification of energy parameters, the energy meters must be reset. Otherwise, all further energy measurements could be incorrect.

Active tariff

When active tariff is set, one of the tariffs (up to four) is defined as active.

Common energy exponent

Common energy exponent defines minimal energy that can be displayed on the energy counter. On the basis of this and a counter divider, a basic calculation prefix for energy is defined (-3 is $10^{-3}\text{Wh} = \text{mWh}$, 4 is $10^4\text{Wh} = 10 \text{ kWh}$). A common energy exponent also influences in setting a number of impulses for energy of pulse output or alarm output functioning as an energy meter.

Define the common energy exponent as recommended in the table below, where counter divider is value 10 as default. Values of primary voltage and current determine a proper common energy exponent.

Current \ Voltage	1 A	5 A	50 A	100 A	1000 A
110 V	-1	0	1	1	2
230 V	0	0	1	2	3
1000 V	0	1	2	3	4
30 kV	2	2	3	4	4*

* Counter divider should be at least 100

Counter divider

Additionally, the counter divider defines precision of a certain counter, according to settings of a common energy exponent. This is done to prevent the counter from having an early energy overflow.

An example for 23.331 kWh of consumed active energy:

Divider	Exponent	Resolution	Displayed
1	0	$1 \times 10^0 = 1 \text{ W}$	23.331 kW
10	0	$10 \times 10^0 = 10 \text{ W}$	23.33 kW
100	0	$100 \times 10^0 = 100 \text{ W}$	0.0233 MW
1000	0	$1000 \times 10^0 = 1 \text{ kW}$	0.023 MW
1	1	$1 \times 10^1 = 10 \text{ W}$	23.33 kW
1	2	$1 \times 10^2 = 100 \text{ W}$	0.0233 MW
1	3	$1 \times 10^3 = 1 \text{ kW}$	0.023 MW
1	4	$1 \times 10^4 = 10 \text{ kW}$	0.02 MW
10	2	$10 \times 10^2 = 1 \text{ kW}$	0.023 MW

Analogue outputs

Number of analogue outputs depends on the version of MTR-3.

Analogue outputs

Each of up to four analogue outputs is fully programmable and can be set to any of 6 full-scale ranges. Within each of those 6 ranges, other required output ranges can be set. For example, 4...20 mA range can be set when ± 20 mA full-scale range is selected:

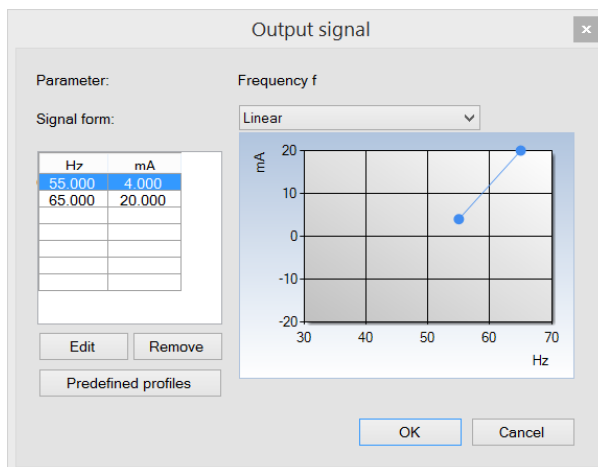

Output parameter

Sets the measured parameter to be transformed onto the analogue output.

Output range

Defines analogue output full-scale ranges:

DC current output	DC voltage output
-1...0...1 mA	-1...0...1 V
-5...0...5 mA	
-10...0...10 mA	-10...0...10 V
-20...0...20 mA	

Output characteristics

Defines the shape and up to 5 break points of an analogue output. For intrinsic-error for analogue outputs with bent or linear zoom characteristic multiply accuracy class with correction factor (c). Correction factor c (the highest value applies):

Linear characteristic	Bent characteristic
$1 - \frac{y_0}{y_e}$ $c = \frac{y_e}{1 - \frac{x_0}{x_e}} \quad \text{or} \quad c = 1$	$x_{b-1} \leq x \leq x_b \quad b - \text{number of break points (1 to 5)}$ $c = \frac{y_b - y_{b-1}}{x_b - x_{b-1}} \cdot \frac{x_e}{y_e} \quad \text{or} \quad c = 1$

Example of settings with linear and bent characteristic:

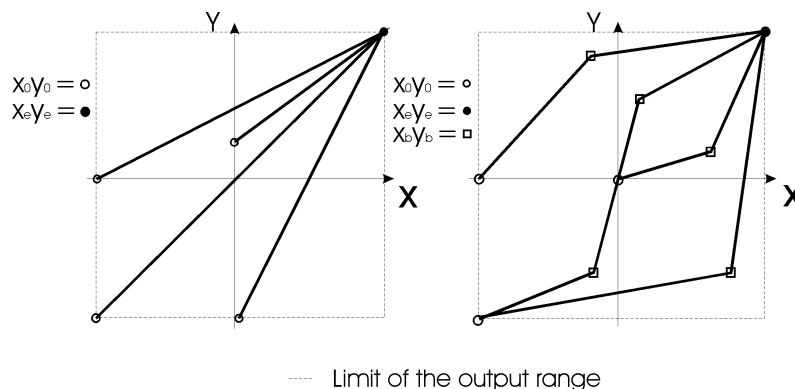

Average interval for analogue output

Defines the average interval for measurements on the analogue output. Available settings are from 1 period (0.02 sec by 50 Hz) up to 128 periods (2.56 sec by 50 Hz).

Fast analogue output PC

Functionality of the fast analogue output module is the same as with the standard analogue output module.

The only difference is its faster response time (≤ 50 ms), and consequential higher ripple. For a proper behaviour of the fast analogue output module (fast response), the average interval must be set to minimum (1 period).

Relay output module PC

Relay output module can be assigned different functions.

- Alarm notification functionality (alarm output)
- Pulse output for energy measurement (pulse output)
- General purpose digital output (digital output)

Pulse output functionality PC

A corresponding energy counter (up to 4) can be assigned to a pulse output. A number of pulses per energy unit, pulse length, and a tariff in which output is active are set.



Pulse parameters are defined by SIST EN 62053–31 standard. In the section “Calculation of recommended pulse parameters” below, a simplified rule is described to assist you in setting the pulse output parameters.

Calculation of recommended pulse parameters

Number of pulses per energy unit should be in certain limits according to expected power. If not so, the measurement from pulse output can be incorrect. Settings of current and voltage transformers can help in estimation of expected power.

Principle described below for pulse setting, where e is prefix, satisfies SIST EN 62053–31: 2001 standards pulse specifications:

$$1.5K\ 15\ eW \rightarrow 100\ p/1\ eWh$$

Examples:

Expected power	→	Pulse output settings
150 – 1500 kW	→	1 p/1kWh
1.5 – 15 MW	→	100 p/1MWh
15 – 150 MW	→	10 p/1MWh
150 – 1500 MW	→	1 p/1MWh

Alarm notification functionality PC

An alarm notification function can also be assigned to output. In case of any alarm occurrence, alarm output will trigger passive electromechanical relay or passive solid-state relay.

Two parameters should be defined for each alarm output:

- The source for assigned alarm (alarm group 1, 2 or both)
- Type of output signal when alarm is detected.

General purpose digital output PC

This functionality allows user to enable/disable output relay by software settings (when appropriate values are set in Modbus table).

MODULE NUMBER	MODBUS REGISTER	REGISTER VALUE	
Module 1 (if installed)	40722	3 - ON	4 - OFF
Module 2 (if installed)	40725	3 - ON	4 - OFF
Module 3 (if installed)	40728	3 - ON	4 - OFF
Module 4 (if installed)	40731	3 - ON	4 - OFF

Alarms

Alarms are used for alarming exceeded set values of the measured quantities.

Alarms setting PC

MTR-3 supports recording and storage of 16 alarms in two groups. For each group of alarms, a time constant of maximal values in thermal mode, a delay time and alarm deactivation hysteresis can be defined.

Quantity, value (a current value or a MD – thermal function) are defined for every individual alarm.



New values of alarms are calculated in percentage at the modification of the connection settings. If used voltage, current range is changed, the limit values of alarms will change proportionally.

Reset operations

Reset energy counters (E1, E2, E3, E4) PC

All or individual energy meters are reset.

Reset MD values PC

Current and stored MDs are reset.

Reset the last MD period PC

Current MD value is reset.

Reset alarm output PC

All alarms are reset.

6. Measurements

Introduction

In the following chapters, the device operation is explained in more details.

Supported measurements

Selection of supported measurements is changed with the connection settings. All supported measurements can be read via communication (M-Set and Modbus).

Available connections

Different electric connections are described in more details in “Electric connection” in chapter 4 “Connection”. Connections are marked as follows:

- Connection 1b (1W) – single phase connection
- Connection 3b (1W3) – three-phase – three-wire connection with balanced load
- Connection 4b (1W4) – three-phase – four-wire connection with balanced load
- Connection 3u (2W3) – three-phase – three-wire connection with unbalanced load
- Connection 4u (3W4) – three-phase – four-wire connection with unbalanced load



Measurement support depends on the connection mode of the instrument type. Calculated measurements are only informative.

Survey of supported measurements regarding connection mode

	Basic measurements	Designat.	Unit	1b	3b	3u	4b	4u
Phase	Voltage U_1	U1	V	•	×	×	•	•
	Voltage U_2	U2	V	×	×	×	○	•
	Voltage U_3	U3	V	×	×	×	○	•
	Average voltage U^-	U_{Δ}	V	×	×	×	○	•
	Current I_1	I1	A	•	•	•	•	•
	Current I_2	I2	A	×	○	•	○	•
	Current I_3	I3	A	×	○	•	○	•
	Current I_n	I _{nc}	A	×	○	○	○	•
	Total current I_t	I	A	•	○	○	○	•
	Average current I_a	I _{avg}	A	×	○	○	○	•
	Active power P_1	P1	W	•	×	×	•	•
	Active power P_2	P2	W	×	×	×	○	•
	Active power P_3	P3	W	×	×	×	○	•
	Total active power P_t	P	W	•	•	•	○	•
	Reactive power Q_1	Q1	VAr	•	×	×	•	•
	Reactive power Q_2	Q2	VAr	×	×	×	○	•
	Reactive power Q_3	Q3	VAr	×	×	×	○	•
Total reactive power Q_t	Q	VAr	•	•	•	○	•	

• – supported ○ – calculated × – not supported

	Basic measurements	Designat.	Unit	1b	3b	3u	4b	4u
Phase	Apparent power S_1	S1	VA	●	×	×	●	●
	Apparent power S_2	S2	VA	×	×	×	○	●
	Apparent power S_3	S3	VA	×	×	×	○	●
	Total apparent power S_t	S	VA	●	●	●	○	●
	Power factor PF_1	PF1/ePF1		●	×	×	●	●
	Power factor PF_2	PF2/ePF2		×	×	×	○	●
	Power factor PF_3	PF3/ePF3		×	×	×	○	●
	Total power factor PF^-	PF/ePF		●	●	●	○	●
	Power angle φ_1	φ_1	°	●	×	×	●	●
	Power angle φ_2	φ_2	°	×	×	×	○	●
	Power angle φ_3	φ_3	°	×	×	×	○	●
	Total power angle φ^-	φ	°	●	●	●	○	●
	THD of phase voltage U_{r1}	U1 %	%THD	●	×	×	●	●
	THD of phase voltage U_{r2}	U2 %	%THD	×	×	×	○	●
	THD of phase voltage U_{r3}	U3 %	%THD	×	×	×	○	●
Phase-to-phase	THD of phase current I_1	I1 %	%THD	●	●	●	●	●
	THD of phase current I_2	I2 %	%THD	×	○	●	○	●
	THD of phase current I_3	I3 %	%THD	×	○	●	○	●
	Phase-to-phase voltage U_{12}	U12	V	×	●	●	○	●
	Phase-to-phase voltage U_{23}	U23	V	×	●	●	○	●
	Phase-to-phase voltage U_{31}	U31	V	×	●	●	○	●
	Average phase-to-phase voltage (U_{ff})	U_{Δ}	V	×	●	●	○	●
	Phase-to-phase angle φ_{12}	φ_{12}	°	×	×	×	○	●
	Phase-to-phase angle φ_{23}	φ_{23}	°	×	×	×	○	●
Phase-to-phase angle φ_{31}	φ_{31}	°	×	×	×	○	●	
THD of phase-to-phase voltage U_{12}	U12 %	%THD	×	●	●	○	●	
THD of phase-to-phase voltage U_{23}	U23 %	%THD	×	●	●	○	●	
THD of phase-to-phase voltage U_{31}	U31 %	%THD	×	●	●	○	●	
Energy	Counters 1-4	E1, E2, E3, E4	Wh VAh VArh	●	●	●	●	●
	Active tariff	Atar		●	●	●	●	●
Max. values MD	MD current I_1	I1	A	●	●	●	●	●
	MD current I_2	I2	A	×	○	●	○	●
	MD current I_3	I3	A	×	○	●	○	●
	MD active power P (positive)	P+	W	●	●	●	●	●
	MD active power P (negative)	P-	W	●	●	●	●	●
	MD reactive power Q-L	Q_{L}	VAr	●	●	●	●	●
	MD reactive power Q-C	Q_{C}	VAr	●	●	●	●	●
	MD apparent power S	S	VA	●	●	●	●	●

● – supported ○ – calculated × – not supported



For 3b and 3u connection modes, only phase-to-phase voltages are measured. Because of that, factor $\sqrt{3}$ is applied to calculation of quality considering nominal phase voltage.

For 4u connection mode, measurement support is the same as for 1b.

Explanation of basic concepts

Sample factor – M_V

A meter measures all primary quantities with sample frequency which cannot exceed a certain number of samples in a time period. Based on these limitations (65 Hz·128 samples) a sample factor is calculated. A sample factor (M_V), depending on frequency of a measured signal, defines a number of periods for a measurement calculation and thus a number of harmonics considered in THD calculations.

Average interval – M_P

Due to readability of measurements from communication, an average interval (M_P) is calculated with regard to the measured signal frequency. The average interval (see “Average interval” on page 16) defines the refresh rate of displayed measurements based on a sampling factor.

Power and energy flow

The figure below shows a flow of active power, reactive power and energy for 4u connection.

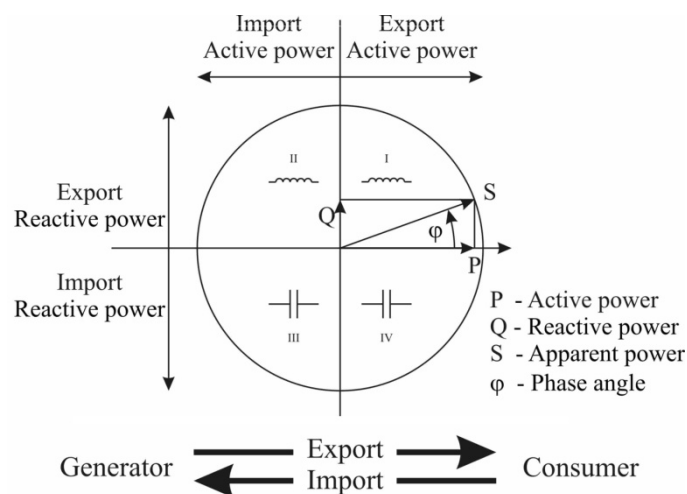

The power and energy flow is defined as standard from a generator's point of view. This means that a consumer using energy will be exporting power. It is possible to change export/import definition via the M-Set, by changing the energy flow direction.

Calculation and display of measurements

This chapter deals with capture, calculation and display of all supported quantities of measurement. Only the most important equations are described; however, all of them are shown in chapter 8, “Appendix B: Calculations and equations” on page 36 with additional descriptions and explanations.



Calculation and display of measurements depend on the used connection. For more detailed information, see “Survey of supported measurements regarding connection mode” on page 23.

Present values

All values are calculated as an average of number of periods set in general settings/average interval.

Voltage PC

The instrument measures true RMS values of all phase voltages (U1, U2, U3), connected to the transducer. Phase-to-phase voltages (U12, U23, U31), average phase voltage (Uf) and average phase-to-phase voltage (Ua) are calculated from measured phase voltages (U1, U2, U3).

$$U_f = \sqrt{\frac{\sum_{n=1}^N u_n^2}{N}} \quad U_{xy} = \sqrt{\frac{\sum_{n=1}^N (u_{xn} - u_{yn})^2}{N}}$$

All voltage measurements are available via communication.

Current PC

Instrument measures true RMS values of phase currents, connected to current inputs. Neutral current (In), average current (Ia) and a sum of all phase currents (It) are calculated from phase currents.

$$I_{RMS} = \sqrt{\frac{\sum_{n=1}^N i_n^2}{N}}$$

All current measurements are available via communication.

Active, reactive and apparent power PC

Active power is calculated from instantaneous phase voltages and currents. Two different principles of reactive power calculation are used:

Standard method:

With this method, a reactive power is calculated based on the assumption that all power which is not active is reactive.

$$Q^2 = S^2 - P^2$$

This also means that all higher harmonics will be measured as reactive power.

Delayed current method:

With this method, reactive power (energy) is calculated by multiplication of voltage samples and delayed current samples (see chapter 8, "Appendix B: Calculations and equations" on page 36:

$$Q = U \times I|_{+90^\circ}$$

With this method, reactive power (energy) only represents the true reactive component of apparent power (energy).

All measurements are seen via communication. For more detailed information about calculation, see chapter 8, "Appendix B: Calculations and equations" on page 36.

Power factor and power angle PC

Power factor is calculated as quotient of active and apparent power for each phase separately ($\cos\phi_1, \cos\phi_2, \cos\phi_3$) and total power angle ($\cos\phi_t$). For correct display of PF via analogue output and application of the alarm, ePF (extended power factor) is applied. It illustrates power factor with one value as described in the table below. For a display on the remote display, both of them have an equal display function: between -1 and 1 with the icon for inductive or capacitive load.

Load	C	→		←	L
Angle [°]	-180	-90	0	+90	+180 (179.99)
PF	-1	0	1	0	-1
ePF	-1	0	1	2	3

Example of analogue output for PF and ePF:

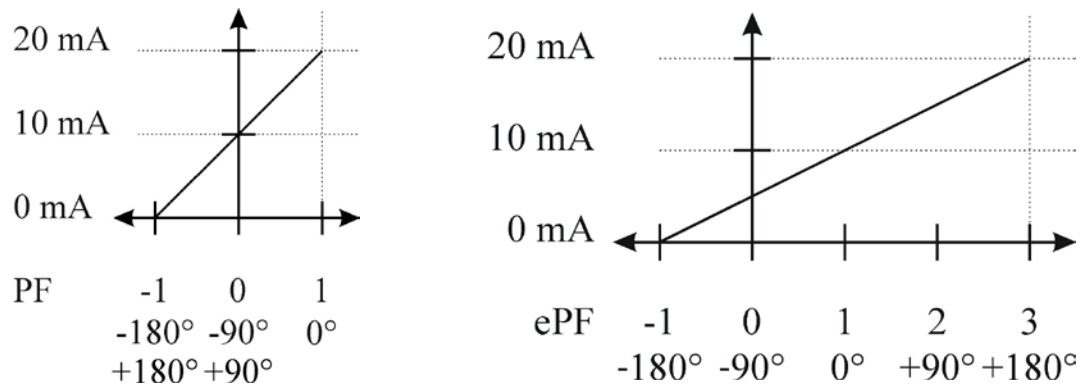

The power angle represents the angle between the first voltage harmonic and the first current harmonic for each individual phase. The total power angle is calculated from the total active and reactive power (see equations for total power angle, in chapter 8, "Appendix B: Calculations and equations on page 36). A positive sign shows inductive load, and a negative sign shows capacitive load.

Frequency PC

Network frequency is calculated from time periods of measured voltage. Frequency is an average of number of periods set in general settings/average interval.

Energy PC

The energy of each of four energy counters is available.

MD values PC

Measurements of MD values.

THD – Total Harmonic Distortion PC

THD is calculated for phase currents, phase and phase-to-phase voltages and is expressed as percent of high harmonic components regarding RMS value or relative to first harmonic.

The instrument uses a measuring technique of true RMS values that assures exact measurements with the presence of high harmonics up to 31st harmonic.

7. Appendix A: Modbus protocol

Modbus communication protocol

Modbus is enabled via RS485 or USB. The response is the same type as the request.

Two versions of Modbus register tables are available:

- VERSION 1: MTR-3 Modbus registers
- VERSION 2: Compatibility with previous version of the product, the MTR-2

Modbus

Modbus protocol enables operation of device on Modbus networks. For device with serial communication, the Modbus protocol enables point-to-point (for example device to PC) multi-drop communication via RS485 communication. Modbus protocol is a widely supported open interconnect originally designed by Modicon.

The memory reference for input and holding registers is 300001 and 400001 respectively.

The register tables on the next pages show both the PLC address and Modbus address to read from the desired register.

Example for reading Frequency parameter:

PLC: Read address 300106-300107

Modbus: Read address 105-106 with function 4

The Modbus address will always be 1 lower than the PLC address because PLC addresses start with 1 where Modbus addresses start with 0.

VERSION 1:**Register table for the actual measurements**

Parameter	PLC		Modbus Reading			
	Address		Address		Function	Type
	Start	End	Start	End		
Frequency	300106	300107	105	106	04	T5
U1	300108	300109	107	108	04	T5
U2	300110	300111	109	110	04	T5
U3	300112	300113	111	112	04	T5
Uavg (phase to neutral)	300114	300115	113	114	04	T5
φ_{12} (angle between U1 and U2)	300116	300116	115	115	04	T17
φ_{23} (angle between U2 and U3)	300117	300117	116	116	04	T17
φ_{31} (angle between U3 and U1)	300118	300118	117	117	04	T17
U12	300119	300120	118	119	04	T5
U23	300121	300122	120	121	04	T5
U31	300123	300124	122	123	04	T5
Uavg (phase to phase)	300125	300126	124	125	04	T5
I1	300127	300128	126	127	04	T5
I2	300129	300130	128	129	04	T5
I3	300131	300132	130	131	04	T5
INc	300133	300134	132	133	04	T5
INm - reserved	300135	300136	134	135	04	T5
Iavg	300137	300138	136	137	04	T5
ΣI	300139	300140	138	139	04	T5
Active Power Total (Pt)	300141	300142	140	141	04	T6
Active Power Phase L1 (P1)	300143	300144	142	143	04	T6
Active Power Phase L2 (P2)	300145	300146	144	145	04	T6
Active Power Phase L3 (P3)	300147	300148	146	147	04	T6
Reactive Power Total (Qt)	300149	300150	148	149	04	T6
Reactive Power Phase L1 (Q1)	300151	300152	150	151	04	T6
Reactive Power Phase L2 (Q2)	300153	300154	152	153	04	T6
Reactive Power Phase L3 (Q3)	300155	300156	154	155	04	T6
Apparent Power Total (St)	300157	300158	156	157	04	T5
Apparent Power Phase L1 (S1)	300159	300160	158	159	04	T5
Apparent Power Phase L2 (S2)	300161	300162	160	161	04	T5
Apparent Power Phase L3 (S3)	300163	300164	162	163	04	T5
Power Factor Total (PFt)	300165	300166	164	165	04	T7
Power Factor Phase 1 (PF1)	300167	300168	166	167	04	T7
Power Factor Phase 2 (PF2)	300169	300170	168	169	04	T7
Power Factor Phase 3 (PF3)	300171	300172	170	171	04	T7
Power Angle Total atan2(Pt,Qt)	300173	300173	172	172	04	T17
φ_1 (angle between U1 and I1)	300174	300174	173	173	04	T17
φ_2 (angle between U2 and I2)	300175	300175	174	174	04	T17
φ_3 (angle between U3 and I3)	300176	300176	175	175	04	T17
Internal Temperature	300182	300182	181	181	04	T17

Register table for the actual measurements (VERSION 1)

Parameter	PLC		Modbus Reading			
	Address		Address		Function	Type
	Start	End	Start	End		
Reactive Power Total (Qt)	300149	300150	148	149	04	T6
Reactive Power Phase L1 (Q1)	300151	300152	150	151	04	T6
Reactive Power Phase L2 (Q2)	300153	300154	152	153	04	T6
Reactive Power Phase L3 (Q3)	300155	300156	154	155	04	T6
Apparent Power Total (St)	300157	300158	156	157	04	T5
Apparent Power Phase L1 (S1)	300159	300160	158	159	04	T5
Apparent Power Phase L2 (S2)	300161	300162	160	161	04	T5
Apparent Power Phase L3 (S3)	300163	300164	162	163	04	T5
Power Factor Total (PFt)	300165	300166	164	165	04	T7
Power Factor Phase 1 (PF1)	300167	300168	166	167	04	T7
Power Factor Phase 2 (PF2)	300169	300170	168	169	04	T7
Power Factor Phase 3 (PF3)	300171	300172	170	171	04	T7
Power Angle Total (atan2(Pt,Qt))	300173	300173	172	172	04	T17
ϕ_1 (angle between U1 and I1)	300174	300174	173	173	04	T17
ϕ_2 (angle between U2 and I2)	300175	300175	174	174	04	T17
ϕ_3 (angle between U3 and I3)	300176	300176	175	175	04	T17
Internal Temperature	300182	300182	181	181	04	T17
THD HARMONIC DATA						
U1 THD%	300183	300183	182	182	04	T16
U2 THD%	300184	300184	183	183	04	T16
U3 THD%	300185	300185	184	184	04	T16
U12 THD%	300186	300186	185	185	04	T16
U23 THD%	300187	300187	186	186	04	T16
U31 THD%	300188	300188	187	187	04	T16
I1 THD%	300189	300189	188	188	04	T16
I2 THD%	300190	300190	189	189	04	T16
I3 THD%	300191	300191	190	190	04	T16
I/O STATUS						
Alarm Status Flags (No. 1...16)	300192	300192	191	191	04	T1
I/O 1 Value	300194	300194	193	193	04	T17
I/O 2 Value	300195	300195	194	194	04	T17
I/O 3 Value	300196	300196	195	195	04	T17
I/O 4 Value	300197	300197	196	196	04	T17
ENERGY (see note)						
Energy Counter 1 Exponent	300401	300401	400	400	04	T2
Energy Counter 2 Exponent	300402	300402	401	401	04	T2
Energy Counter 3 Exponent	300403	300403	402	402	04	T2
Energy Counter 4 Exponent	300404	300404	403	403	04	T2
Current Active Tariff	300405	300405	404	404	04	T1
Energy Counter 1	300406	300407	405	406	04	T3
Energy Counter 2	300408	300409	407	408	04	T3
Energy Counter 3	300410	300411	409	410	04	T3
Energy Counter 4	300412	300413	411	412	04	T3

Note: Energy counters actual value is calculated: Counter * 10^{Exponent}

Register table for the actual measurements (VERSION 1)

Parameter	PLC		Modbus Reading			
	Address		Address		Function	Type
	Start	End	Start	End		
DYNAMIC DEMAND VALUES						
Time Into Period (minutes)	300502	300502	501	501	04	T1
I1	300503	300504	502	503	04	T5
I2	300505	300506	504	505	04	T5
I3	300507	300508	506	507	04	T5
Apparent Power Total (St)	300509	300510	508	509	04	T5
Active Power Total (Pt) - (positive)	300511	300512	510	511	04	T6
Active Power Total (Pt) - (negative)			512	513		
Reactive Power Total (Qt) - L	300515	300516	514	515	04	T6
Reactive Power Total (Qt) - C	300517	300518	516	517	04	T6
MAX DEMAND SINCE LAST RESET						
I1	300519	300520	518	519	04	T5
I2	300525	300526	524	525	04	T5
I3	300531	300532	530	531	04	T5
Apparent Power Total (St)	300537	300538	536	537	04	T5
Active Power Total (Pt) - (positive)	300543	300544	542	543	04	T6
Active Power Total (Pt) - (negative)			548	549		
Reactive Power Total (Qt) - L	300555	300556	554	555	04	T6
Reactive Power Total (Qt) - C	300561	300562	560	561	04	T6

MEASUREMENTS (IEEE 754) (VERSION 1)

Parameter	PLC		Modbus reading			
	Address		Address		Function	Type
	Start	End	Start	End		
Uavg (phase to neutral)	30248 5	302486	2484	2485	04	T_float
Uavg (phase to phase)	30248 7	302488	2486	2487	04	T_float
Sum I	30248 9	302490	2488	2489	04	T_float
Active Power Total (Pt)	30249 1	302492	2490	2491	04	T_float
Reactive Power Total (Qt)	30249 3	302494	2492	2493	04	T_float
Apparent Power Total (St)	30249 5	302496	2494	2495	04	T_float
Power Factor Total (PFt)	30249 7	302498	2496	2497	04	T_float
Frequency	30249 9	302500	2498	2499	04	T_float
U1	30250 1	302502	2500	2501	04	T_float
U2	30250 3	302504	2502	2503	04	T_float
U3	30250 5	302506	2504	2505	04	T_float
Uavg (phase to neutral)	30250 7	302508	2506	2507	04	T_float
U12	30250 9	302510	2508	2509	04	T_float
U23	30251 1	302512	2510	2511	04	T_float
U31	30251 3	302514	2512	2513	04	T_float
Uavg (phase to phase)	30251 5	302516	2514	2515	04	T_float
I1	30251 7	302518	2516	2517	04	T_float
I2	30251 9	302520	2518	2519	04	T_float
I3	30252 1	302522	2520	2521	04	T_float
Sum I	30252 3	302524	2522	2523	04	T_float
I neutral (calculated)	30252 5	302526	2524	2525	04	T_float
I neutral (measured)	30252 7	302528	2526	2527	04	T_float
Iavg	30252 9	302530	2528	2529	04	T_float
Active Power Phase L1 (P1)	30253 1	302532	2530	2531	04	T_float
Active Power Phase L2 (P2)	30253 3	302534	2532	2533	04	T_float
Active Power Phase L3 (P3)	30253 5	302536	2534	2535	04	T_float

Active Power Total (Pt)	30253 7	302538	2536	2537	04	T_float
Reactive Power Phase L1 (Q1)	30253 9	302540	2538	2539	04	T_float
Reactive Power Phase L2 (Q2)	30254 1	302542	2540	2541	04	T_float
Reactive Power Phase L3 (Q3)	30254 3	302544	2542	2543	04	T_float
Reactive Power Total (Qt)	30254 5	302546	2544	2545	04	T_float
Apparent Power Phase L1 (S1)	30254 7	302548	2546	2547	04	T_float
Apparent Power Phase L2 (S2)	30254 9	302550	2548	2549	04	T_float
Apparent Power Phase L3 (S3)	30255 1	302552	2550	2551	04	T_float
Apparent Power Total (St)	30255 3	302554	2552	2553	04	T_float
Power Factor Phase 1 (PF1)	30255 5	302556	2554	2555	04	T_float
Power Factor Phase 2 (PF2)	30255 7	302558	2556	2557	04	T_float
Power Factor Phase 3 (PF3)	30255 9	302560	2558	2559	04	T_float
Power Factor Total (PFt)	30256 1	302562	2560	2561	04	T_float
CAP/IND P. F. Phase 1 (PF1)	30256 3	302564	2562	2563	04	T_float
CAP/IND P. F. Phase 2 (PF2)	30256 5	302566	2564	2565	04	T_float
CAP/IND P. F. Phase 3 (PF3)	30256 7	302568	2566	2567	04	T_float
CAP/IND P. F. Total (PFt)	30256 9	302570	2568	2569	04	T_float
ϕ_1 (angle between U1 and I1)	30257 1	302572	2570	2571	04	T_float
ϕ_2 (angle between U2 and I2)	30257 3	302574	2572	2573	04	T_float
ϕ_3 (angle between U3 and I3)	30257 5	302576	2574	2575	04	T_float
Power Angle Total atan2(Pt,Qt)	30257 7	302578	2576	2577	04	T_float

MEASUREMENTS (IEEE 754) (VERSION 1)

Parameter	PLC		Modbus reading			
	Address		Address		Funktion	Type
	Start	End	Start	End		
ϕ_{12} (angle between U1 and U2)	30257 9	302580	2578	2579	04	T_float
ϕ_{23} (angle between U2 and U3)	30258 1	302582	2580	2581	04	T_float
ϕ_{31} (angle between U3 and U1)	30258 3	302584	2582	2583	04	T_float
Frequency	30258 5	302586	2584	2585	04	T_float

Reserved	30258 7	302588	2586	2587		
I1 THD%	30258 9	302590	2588	2589	04	T_float
I2 THD%	30259 1	302592	2590	2591	04	T_float
I3 THD%	30259 3	302594	2592	2593	04	T_float
U1 THD%	30259 5	302596	2594	2595	04	T_float
U2 THD%	30259 7	302598	2596	2597	04	T_float
U3 THD%	30259 9	302600	2598	2599	04	T_float
U12 THD%	30260 1	302602	2600	2601	04	T_float
U23 THD%	30260 3	302604	2602	2603	04	T_float
U31 THD%	30260 5	302606	2604	2605	04	T_float
MAX DEMAND SINCE LAST RESET						
Active Power Total (Pt) - (positive)	30260 7	302608	2606	2607	04	T_float
Active Power Total (Pt) - (negative)	30260 9	302610	2608	2609	04	T_float
Reactive Power Total (Qt) - L	30261 1	302612	2610	2611	04	T_float
Reactive Power Total (Qt) - C	30261 3	302614	2612	2613	04	T_float
Apparent Power Total (St)	30261 5	302616	2614	2615	04	T_float
I1	30261 7	302618	2616	2617	04	T_float
I2	30261 9	302620	2618	2619	04	T_float
I3	30262 1	302622	2620	2621	04	T_float
DYNAMIC DEMAND VALUES						
Active Power Total (Pt) - (positive)	30262 3	302624	2622	2623	04	T_float
Active Power Total (Pt) - (negative)	30262 5	302626	2624	2625	04	T_float
Reactive Power Total (Qt) - L	30262 7	302628	2626	2627	04	T_float
Reactive Power Total (Qt) - C	30262 9	302630	2628	2629	04	T_float
Apparent Power Total (St)	30263 1	302632	2630	2631	04	T_float
I1	30263 3	302634	2632	2633	04	T_float
I2	30263 5	302636	2634	2635	04	T_float
I3	30263 7	302638	2636	2637	04	T_float

ENERGY						
Energy Counter 1	30263 9	302640	2638	2639	04	T_float
Energy Counter 2	30264 1	302642	2640	2641	04	T_float
Energy Counter 3	30264 3	302644	2642	2643	04	T_float
Energy Counter 4	30264 5	302646	2644	2645	04	T_float
Reserved	30264 7	302656	2646	2655		
Aktiv Tariff	30265 7	302658	2656	2657	04	T_float
Internal Temperature	30265 9	302660	2658	2659	04	T_float

Register table for the normalised actual measurements (in %) (VERSION 1)

Parameter	PLC		Modbus Reading				100% value
	Address		Address		Function	Type	
	Start	End	Start	End			
U1	300802	300802	801	801	04	T16	Un
U2	300803	300803	802	802	04	T16	Un
U3	300804	300804	803	803	04	T16	Un
Uavg (phase to neutral)	300805	300805	804	804	04	T16	Un
U12	300806	300806	805	805	04	T16	Un
U23	300807	300807	806	806	04	T16	Un
U31	300808	300808	807	807	04	T16	Un
Uavg (phase to phase)	300809	300809	808	808	04	T16	Un
I1	300810	300810	809	809	04	T16	In
I2	300811	300811	810	810	04	T16	In
I3	300812	300812	811	811	04	T16	In
ΣI	300813	300813	812	812	04	T16	It
I neutral (calculated)	300814	300814	813	813	04	T16	In
I neutral (measured)	300815	300815	814	814	04	T16	In
Iavg	300816	300816	815	815	04	T16	In
Active Power Phase L1 (P1)	300817	300817	816	816	04	T17	Pn
Active Power Phase L2 (P2)	300818	300818	817	817	04	T17	Pn
Active Power Phase L3 (P3)	300819	300819	818	818	04	T17	Pn
Active Power Total (Pt)	300820	300820	819	819	04	T17	Pt
Reactive Power Phase L1 (Q1)	300821	300821	820	820	04	T17	Pn
Reactive Power Phase L2 (Q2)	300822	300822	821	821	04	T17	Pn
Reactive Power Phase L3 (Q3)	300823	300823	822	822	04	T17	Pn
Reactive Power Total (Qt)	300824	300824	823	823	04	T17	Pt
Apparent Power Phase L1 (S1)	300825	300825	824	824	04	T16	Pn
Apparent Power Phase L2 (S2)	300826	300826	825	825	04	T16	Pn
Apparent Power Phase L3 (S3)	300827	300827	826	826	04	T16	Pn
Apparent Power Total (St)	300828	300828	827	827	04	T16	Pt
Power Factor Phase 1 (PF1)	300829	300829	828	828	04	T17	1
Power Factor Phase 2 (PF2)	300830	300830	829	829	04	T17	1
Power Factor Phase 3 (PF3)	300831	300831	830	830	04	T17	1
Power Factor Total (PFt)	300832	300832	831	831	04	T17	1
CAP/IND P. F. Phase 1 (PF1)	300833	300833	832	832	04	T17	1
CAP/IND P. F. Phase 2 (PF2)	300834	300834	833	833	04	T17	1
CAP/IND P. F. Phase 3 (PF3)	300835	300835	834	834	04	T17	1
CAP/IND P. F. Total (PFt)	300836	300836	835	835	04	T17	1
$\varphi 1$ (angle between U1 and I1)	300837	300837	836	836	04	T17	100°

φ_2 (angle between U2 and I2)	300838	300838	837	837	04	T17	100°
φ_3 (angle between U3 and I3)	300839	300839	838	838	04	T17	100°
Power Angle Total (atan2(Pt,Qt))	300840	300840	839	839	04	T17	100°
φ_{12} (angle between U1 and U2)	300841	300841	840	840	04	T17	100°
φ_{23} (angle between U2 and U3)	300842	300842	841	841	04	T17	100°
φ_{31} (angle between U3 and U1)	300843	300843	842	842	04	T17	100°
Frequency	300844	300843	843	843	04	T17	Fn+10 Hz
I1 THD%	300845	300845	844	844	04	T16	100%
I2 THD%	300846	300846	845	845	04	T16	100%
I3 THD%	300847	300847	846	846	04	T16	100%
U1 THD%	300848	300848	847	847	04	T16	100%
U2 THD%	300849	300849	848	848	04	T16	100%
U3 THD%	300850	300850	849	849	04	T16	100%

Register table for the normalised actual measurements (in %) (VERSION 1)

Parameter	PLC		Modbus Reading				100% value
	Address		Address		Function	Type	
	Start	End	Start	End			
U12 THD%	300851	300851	850	850	04	T16	100%
U23 THD%	300852	300852	851	851	04	T16	100%
U31 THD%	300853	300853	852	852	04	T16	100%
MAX DEMAND SINCE LAST RESET							
Active Power Total (Pt) - (positive)	300854	300854	853	853	04	T16	Pt
Active Power Total (Pt) - (negative)	300855	300855	854	854	04	T16	Pt
Reactive Power Total (Qt) - L	300856	300856	855	855	04	T16	Pt
Reactive Power Total (Qt) - C	300857	300857	856	856	04	T16	Pt
Apparent Power Total (St)	300858	300858	857	857	04	T16	Pt
I1	300859	300859	858	858	04	T16	In
I2	300860	300860	859	859	04	T16	In
I3	300861	300861	860	860	04	T16	In
DYNAMIC DEMAND VALUES							
Active Power Total (Pt) - (positive)	300862	300862	861	861	04	T16	Pt
Active Power Total (Pt) - (negative)	300863	300863	862	862	04	T16	Pt
Reactive Power Total (Qt) - L	300864	300864	863	863	04	T16	Pt
Reactive Power Total (Qt) - C	300865	300865	864	864	04	T16	Pt
Apparent Power Total (St)	300866	300866	865	865	04	T16	Pt
I1	300867	300867	866	866	04	T16	In
I2	300868	300868	867	867	04	T16	In
I3	300869	300869	868	868	04	T16	In
ENERGY							
Energy counter 1	300870	300870	869	869	04	T17	Actual counter value MOD 20000 is returned
Energy counter 2	300871	300871	870	870	04	T17	
Energy counter 3	300872	300872	871	871	04	T17	
Energy counter 4	300873	300873	872	872	04	T17	
Aktiv tariff	300879	300879	878	878	04	T1	
Internal temperature	300880	300880	879	879	04	T17	100°

Register table for the fast response normalised actual measurements (in %) (VERSION 1)

The measurements in the registers below are not averaged and therefore the response time is less than 50 mS.

Parameter	PLC		Modbus Reading				100 % value
	Address		Address		Function	Type	
	Start	End	Start	End			
U1	300902	300902	901	901	04	T16	Un
U2	300903	300903	902	902	04	T16	Un
U3	300904	300904	903	903	04	T16	Un
Uavg (phase to neutral)	300905	300905	904	904	04	T16	Un
U12	300906	300906	905	905	04	T16	Un
U23	300907	300907	906	906	04	T16	Un
U31	300908	300908	907	907	04	T16	Un
Uavg (phase to phase)	300909	300909	908	908	04	T16	Un
I1	300910	300910	909	909	04	T16	In
I2	300911	300911	910	910	04	T16	In
I3	300912	300912	911	911	04	T16	In
ΣI	300913	300913	912	912	04	T16	It
I neutral (calculated)	300914	300914	913	913	04	T16	In
I neutral (measured)	300915	300915	914	914	04	T16	In
Iavg	300916	300916	915	915	04	T16	In
Active Power Phase L1 (P1)	300917	300917	916	916	04	T17	Pn
Active Power Phase L2 (P2)	300918	300918	917	917	04	T17	Pn
Active Power Phase L3 (P3)	300919	300919	918	918	04	T17	Pn
Active Power Total (Pt)	300920	300920	919	919	04	T17	Pt
Reactive Power Phase L1 (Q1)	300921	300921	920	920	04	T17	Pn
Reactive Power Phase L2 (Q2)	300922	300922	921	921	04	T17	Pn
Reactive Power Phase L3 (Q3)	300923	300923	922	922	04	T17	Pn
Reactive Power Total (Qt)	300924	300924	923	923	04	T17	Pt
Apparent Power Phase L1 (S1)	300925	300925	924	924	04	T16	Pn
Apparent Power Phase L2 (S2)	300926	300926	925	925	04	T16	Pn
Apparent Power Phase L3 (S3)	300927	300927	926	926	04	T16	Pn
Apparent Power Total (St)	300928	300928	927	927	04	T16	Pt
Power Factor Phase 1 (PF1)	300929	300929	928	928	04	T17	1
Power Factor Phase 2 (PF2)	300930	300930	929	929	04	T17	1
Power Factor Phase 3 (PF3)	300931	300931	930	930	04	T17	1
Power Factor Total (PFt)	300932	300932	931	931	04	T17	1
CAP/IND P. F. Phase 1 (PF1)	300933	300933	932	932	04	T17	1
CAP/IND P. F. Phase 2 (PF2)	300934	300934	933	933	04	T17	1
CAP/IND P. F. Phase 3 (PF3)	300935	300935	934	934	04	T17	1
CAP/IND P. F. Total (PFt)	300936	300936	935	935	04	T17	1
$\varphi 1$ (angle between U1 and I1)	300937	300937	936	936	04	T17	100°
$\varphi 2$ (angle between U2 and I2)	300938	300938	937	937	04	T17	100°
$\varphi 3$ (angle between U3 and I3)	300939	300939	938	938	04	T17	100°
Power Angle Total (atan2(Pt,Qt))	300940	300940	939	939	04	T17	100°
$\varphi 12$ (angle between U1 and U2)	300941	300941	940	940	04	T17	100°
$\varphi 23$ (angle between U2 and U3)	300942	300942	941	941	04	T17	100°
$\varphi 31$ (angle between U3 and U1)	300943	300943	942	942	04	T17	100°
Frequency	300944	300944	943	943	04	T17	Fn+10 Hz
Reserved	300945	300945	944	944			
I1 THD%	300946	300946	945	945	04	T16	100%
I2 THD%	300947	300947	946	946	04	T16	100%
I3 THD%	300948	300948	947	947	04	T16	100%
U1 THD%	300949	300949	948	948	04	T16	100%
U2 THD%	300950	300950	949	949	04	T16	100%
U3 THD%	300951	300951	950	950	04	T16	100%
U12 THD%	300952	300952	951	951	04	T16	100%
U23 THD%	300953	300953	952	952	04	T16	100%
U31 THD%	300954	300954	953	953	04	T16	100%

VERSION2 (MTR-2-compatible):**Register table for the actual measurements**

Parameter	PLC		Modbus reading			
	Address		Address		Function	Type
	Start	End	Start	End		
Frequency	300050	300051	49	50	04	T5
U1	300058	300059	57	58	04	T5
U2	300060	300061	59	60	04	T5
U3	300062	300063	61	62	04	T5
Uavg (phase to neutral)	300064	300065	63	64	04	T5
φ_{12} (angle between U1 and U2)	300066	300066	65	65	04	T17
φ_{23} (angle between U2 and U3)	300067	300067	66	66	04	T17
φ_{31} (angle between U3 and U1)	300068	300068	67	67	04	T17
U12	300069	300070	68	69	04	T5
U23	300071	300072	70	71	04	T5
U31	300073	300074	72	73	04	T5
Uavg (phase to phase)	300075	300076	74	75	04	T5
I1	300077	300078	76	77	04	T5
I2	300079	300080	78	79	04	T5
I3	300081	300082	80	81	04	T5
INc	300083	300084	82	83	04	T5
INm - reserved	300085	300086	84	85	04	T5
Iavg	300087	300088	86	87	04	T5
ΣI	300089	300090	88	89	04	T5
Active Power Total (Pt)	300091	300092	90	91	04	T6
Active Power Phase L1 (P1)	300093	300094	92	93	04	T6
Active Power Phase L2 (P2)	300095	300096	94	95	04	T6
Active Power Phase L3 (P3)	300097	300098	96	97	04	T6
Reactive Power Total (Qt)	300099	300100	98	99	04	T6
Reactive Power Phase L1 (Q1)	300101	300102	100	101	04	T6
Reactive Power Phase L2 (Q2)	300103	300104	102	103	04	T6
Reactive Power Phase L3 (Q3)	300105	300106	104	105	04	T6
Apparent Power Total (St)	300107	300108	106	107	04	T5
Apparent Power Phase L1 (S1)	300109	300110	108	109	04	T5
Apparent Power Phase L2 (S2)	300111	300112	110	111	04	T5
Apparent Power Phase L3 (S3)	300113	300114	112	113	04	T5
Power Factor Total (PFt)	300115	300116	114	115	04	T7
Power Factor Phase 1 (PF1)	300117	300118	116	117	04	T7
Power Factor Phase 2 (PF2)	300119	300120	118	119	04	T7
Power Factor Phase 3 (PF3)	300121	300122	120	121	04	T7
Power Angle Total (atan2(Pt,Qt))	300123	300123	122	122	04	T17
φ_1 (angle between U1 and I1)	300124	300124	123	123	04	T17
φ_2 (angle between U2 and I2)	300125	300125	124	124	04	T17
φ_3 (angle between U3 and I3)	300126	300126	125	125	04	T17
Internal Temperature	300127	300127	126	126	04	T17

Register table for the actual measurements (VERSION 2)

Parameter	PLC		Modbus Reading			
	Address		Address		Function	Type
	Start	End	Start	End		
THD HARMONIC DATA						
U1 THD%	300639	300639	639	639	04	T16
U2 THD%	300640	300640	640	640	04	T16
U3 THD%	300641	300641	641	641	04	T16
U12 THD%	300642	300642	642	642	04	T16
U23 THD%	300643	300643	643	643	04	T16
U31 THD%	300644	300644	644	644	04	T16
I1 THD%	300645	300645	645	645	04	T16
I2 THD%	300646	300646	646	646	04	T16
I3 THD%	300647	300647	647	647	04	T16

Parameter	PLC		Modbus reading			
	Address		Address		Function	Type
	Start	End	Start	End		
DYNAMIC DEMAND VALUES						
Time Into Period (minutes)	300175	300175	174	174	04	T1
I1	300176	300177	175	176	04	T5
I2	300178	300179	177	178	04	T5
I3	300180	300181	179	180	04	T5
Apparent Power Total (St)	300182	300183	181	182	04	T5
Active Power Total (Pt) - (positive)	300184	300185	183	184	04	T6
Active Power Total (Pt) - (negative)	300186	300187	185	186	04	T6
Reactive Power Total (Qt) - L	300188	300189	187	188	04	T6
Reactive Power Total (Qt) - C	300190	300191	189	190	04	T6
MAX DEMAND SINCE LAST RESET						
I1	300208	300209	207	208	04	T5
I2	300214	300215	213	214	04	T5
I3	300220	300221	219	220	04	T5
Apparent Power Total (St)	300226	300227	225	226	04	T5
Active Power Total (Pt) - (positive)	300232	300233	231	232	04	T6
Active Power Total (Pt) - (negative)	300238	300239	237	238	04	T6
Reactive Power Total (Qt) - L	300244	300245	243	244	04	T6
Reactive Power Total (Qt) - C	300250	300251	249	250	04	T6

Register table for the normalised actual measurements (VERSION 2)

Parameter	PLC		Modbus Reading				100% value
	Address		Address		Function	Type	
	Start	End	Start	End			
U1	300802	300802	801	801	04	T16	Un
U2	300803	300803	802	802	04	T16	Un
U3	300804	300804	803	803	04	T16	Un
Uavg (phase to neutral)	300805	300805	804	804	04	T16	Un
U12	300806	300806	805	805	04	T16	Un
U23	300807	300807	806	806	04	T16	Un
U31	300808	300808	807	807	04	T16	Un
Uavg (phase to phase)	300809	300809	808	808	04	T16	Un
I1	300810	300810	809	809	04	T16	In
I2	300811	300811	810	810	04	T16	In
I3	300812	300812	811	811	04	T16	In
ΣI	300813	300813	812	812	04	T16	It
I neutral (calculated)	300814	300814	813	813	04	T16	In
I neutral (measured)	300815	300815	814	814	04	T16	In
Iavg	300816	300816	815	815	04	T16	In
Active Power Phase L1 (P1)	300817	300817	816	816	04	T17	Pn
Active Power Phase L2 (P2)	300818	300818	817	817	04	T17	Pn
Active Power Phase L3 (P3)	300819	300819	818	818	04	T17	Pn
Active Power Total (Pt)	300820	300820	819	819	04	T17	Pt
Reactive Power Phase L1 (Q1)	300821	300821	820	820	04	T17	Pn
Reactive Power Phase L2 (Q2)	300822	300822	821	821	04	T17	Pn
Reactive Power Phase L3 (Q3)	300823	300823	822	822	04	T17	Pn
Reactive Power Total (Qt)	300824	300824	823	823	04	T17	Pt
Apparent Power Phase L1 (S1)	300825	300825	824	824	04	T16	Pn
Apparent Power Phase L2 (S2)	300826	300826	825	825	04	T16	Pn
Apparent Power Phase L3 (S3)	300827	300827	826	826	04	T16	Pn
Apparent Power Total (St)	300828	300828	827	827	04	T16	Pt
Power Factor Phase 1 (PF1)	300829	300829	828	828	04	T17	1
Power Factor Phase 2 (PF2)	300830	300830	829	829	04	T17	1
Power Factor Phase 3 (PF3)	300831	300831	830	830	04	T17	1
Power Factor Total (PFt)	300832	300832	831	831	04	T17	1

100 % value calculations for normalised measurements

Un =	$(R40147/R40146) * R39015 * R40149$
In =	$(R40145/R40144) * R39017 * R40148$
Pn =	Un*In
It =	In Connection Mode: 1b
It =	3*In Connection Modes: 3b, 4b, 3u, 4u
Pt =	Pn Connection Mode: 1b
Pt =	3*Pn Connection Modes: 3b, 4b, 3u, 4u
Fn =	R40150

Register table for Settings (VERSION 2)

Parameter	PLC		Modbus reading				Values/dependences
	Address		Address		Type	Ind	
	Start	End	Start	End			
SYSTEM COMMANDS							
User Password (L1, L2)	400001	400002	0	1	T_Str4	A...Z	Password to attempt user access level upgrade
Factory Password (FAC)	400003	400005	2	4	T_Str6	A...Z	Password to attempt factory access level upgrade
Level 1 - User password	400006	400007	5	6	T_Str4	A...Z	
Level 2 - User password	400008	400009	7	8	T_Str4	A...Z	
Active Access Level	400010		9		T1	0	Full protection
						1	Access up to level 1 user password
						2	Access up to level 2 user password
						3	Access up to level 2 (backup pass.)
						4	Factory access level
Manual password activation	400011		10		T1	1	Lock instrument
Operator Command Register	400012		11		T1	1	Save Settings
						2	Abort Settings
						3	Restart Instrument
Reset command register 1	400013		12		T1	Bit-0	Reset counter 1
						Bit-1	Reset counter 2
						Bit-2	Reset counter 3
						Bit-3	Reset counter 4
						Bit-10	Reset last period MD
						Bit-11	Reset MD values
Reset command register 2	400014		13		T1	Bit-0	Reset alarm output relay 1
						Bit-1	Reset alarm output relay 2
						Bit-2	Reset alarm output relay 3
						Bit-3	Reset alarm output relay 4
Reserved	400015	400099	14	98			
GENERAL SETTINGS							
Modbus register tables for measurements	400101		100		T1	0	Version 1 - MTR-3
						1	Version 2 - compatible with MTR-2
Description	400102	400120	101	119	T_Str40		
Location	400123	400140	122	139	T_Str40		
Password activation	400142		141				Reserved
Password lock time	400143		142		T1		Minutes, 0 = No lock
Conection Mode	400144		143		T1	0	No mode
						1	1b - Single Phase
						2	3b - 3 phase 3 wire balanced
						3	4b - 3 phase 4 wire balanced
						4	3u - 3 phase 3 wire unbalanced
						5	4u - 3 phase 4 wire unbalanced
CT Secondary	400145		144		T4		mA
CT Primary	400146		145		T4		A/10
VT Secondary	400147		146		T4		mV
VT Primary	400148		147		T4		V/10
Current input range (%)	400149		148		T16		10000 for 100%
Voltage input range (%)	400150		149		T16		10000 for 100%
Frequency nominal value	400151		150		T1		Hz
CT Connection	400152		151		T1	Bit-0	Disable display "Wrong connection"
						Bit-1	Reverse Energy flow direction
						Bit-2	Reverse CT connection
MD Time constant	400153		152		T1		minutes (0=disabled)

Reserved	400154		153				
Starting total current for PFt & Pat	400155		154		T16		2000 for 20 mA
Starting current for all powers	400156		155		T16		200 for 2 mA
Reserved	400157	400159	156	158			
Temperature unit	400160		159		T1	0	°C
						1	°F
Reserved	400161	400167	160	166			
Starting voltage for SYNC.	400168		167		T1		5000 for 5 V (for R30015 = 500 V)
Reserved	400168	400169	168	169			
Comm. average interval	400171		170		T1	0	1 period (0.02 s @50 Hz) default
						1	2 periods (0.04 s @50 Hz)
						2	4 periods (0.08 s @50 Hz)
						3	8 periods (0.16 s @50 Hz)
						4	16 periods (0.32 s @50 Hz)
						5	32 periods (0.64 s @50 Hz)
						6	64 periods (1.28 s @50 Hz) default
						7	128 periods (2.56 s @50 Hz)
						8	256 periods (5.12 s @50 Hz)
Reserved	400172	400201	171	200			
COMMUNICATION							
Res. for Port 1: Device Address (DNP3)	400201		200				
Port 1: Device Address (Modbus)	400203		202		T1		
Port 1: Baud Rate	400204		203		T1	0	Baud rate 1200
						1	Baud rate 2400
						2	Baud rate 4800
						3	Baud rate 9600
						4	Baud rate 19200
						5	Baud rate 38400
						6	Baud rate 57600
						7	Baud rate 115200
Port 1: Stop Bit	400205		204		T1	0	1 Stop bit
						1	2 Stop bits
Port 1: Parity	400206		205		T1	0	No parity
						1	Odd parity
						2	Even parity
Port 1: Data Bits	400207		206		T1	0	8 bits
						1	7 bits
Reserved	400208	400400	207	399			

Register table for Settings (VERSION 2)

Parameter	PLC		Modbus reading				Values/dependences
	Address		Address		Type	Ind	
	Start	End	Start	End			
ENERGY							
Active Tariff	400401		400		T1	0	Tariff input (Tariff 1, if input not available)
						1..4	Tariff 1..4
Common Energy Counter Exponent	400402		401		T2		
Reserved	400403	400419	402	418			
Reactive power calculation	400420		419		T1	0	Standard calculation (Q2=S2-P2)
						1	Delayed Current method
Energy Counter 1 Parameter	400421		420		T1	0	No Parameter
						1	Active Power
						2	Reactive Power
						3	Apparent Power
						5	Active Power Phase 1
						6	Reactive Power Phase 1
						7	Apparent Power Phase 1
						9	Active Power Phase 2
						10	Reactive Power Phase 2
						11	Apparent Power Phase 2
						13	Active Power Phase 3
						14	Reactive Power Phase 3
						15	Apparent Power Phase 3
						16	Pulse input 1 (reg.40402 not used)
						17	Pulse input 2 (reg.40402 not used)
						18	Pulse input 3 (reg.40402 not used)
						19	Pulse input 4 (reg.40402 not used)
Energy Counter 1 Configuration	400422		421		T1	Bit-0	Quadrant I Enabled
						Bit-1	Quadrant II Enabled
						Bit-2	Quadrant III Enabled
						Bit-3	Quadrant IIII Enabled
						Bit-4	Absolute Value
						Bit-5	Invert Value
Energy Counter 1 Divider	400423		422		T1	0	1
						1	10
						2	100
						3	1000
						4	10000
Energy Counter 1 Tarif Selector	400424		423		T1	Bit-0	Tarif 1 Enabled
						Bit-1	Tarif 2 Enabled
						Bit-2	Tarif 3 Enabled
						Bit-3	Tarif 4 Enabled
Reserved	400425	400430	424	429			
Energy Counter 2 Parameter	400431		430		T1		see Energy Counter 1 Param.
Energy Counter 2 Configuration	400432		431		T1		see Energy Counter 1 Config.
Energy Counter 2 Divider	400433		432		T1		see Energy Counter 1 Divider
Energy Counter 2 Tarif Selector	400434		433		T1		see Energy Counter 1 Tarif Selector
Reserved	400435	400440	434	439			
Energy Counter 3 Parameter	400441		440		T1		see Energy Counter 1 Param.
Energy Counter 3 Configuration	400442		441		T1		see Energy Counter 1 Config.
Energy Counter 3 Divider	400443		442		T1		see Energy Counter 1 Divider
Energy Counter 3 Tarif Selector	400444		443		T1		see Energy Counter 1 Tarif Selector

Reserved	400445	400450	444	449			
Energy Counter 4 Parameter	400451		450		T1		see Energy Counter 1 Param.
Energy Counter 4 Configuration	400452		451		T1		see Energy Counter 1 Config.
Energy Counter 4 Divider	400453		452		T1		see Energy Counter 1 Divider
Energy Counter 4 Tarif Selector	400454		453		T1		see Energy Counter 1 Tarif Selector
Reserved	400455	400800	454	799			
ANALOGUE OUTPUTS							
Reserved	400801		800				
Reserved	400802		801				
Output 1 type	400803		802		T1	0	1 mA
						1	5 mA
						2	10 mA
						3	20 mA
						4	1 V
						5	10 V
Output 1 Parameter	400804		803		T1		See OutTypes
Output 1 Function Type	400805		804		T1	0	Linear
Output 1 Number of Breakpoints	400806		805		T1	1	Quadratic
Output 1 Lower X Point (X0)	400807		806		T17		% of parameter value
Output 1 Lower Y Point (Y0)	400808		807		T17		% of output type
Output 1 X Breakpoint 1 (X1)	400809		808		T17		% of parameter value
Output 1 Y Breakpoint 1 (Y1)	400810		809		T17		% of output type
Output 1 X Breakpoint 2 (X2)	400811		810		T17		% of parameter value
Output 1 Y Breakpoint 2 (Y2)	400812		811		T17		% of output type
Output 1 X Breakpoint 3 (X3)	400813		812		T17		% of parameter value
Output 1 Y Breakpoint 3 (Y3)	400814		813		T17		% of output type
Output 1 X Breakpoint 4 (X4)	400815		814		T17		% of parameter value
Output 1 Y Breakpoint 4 (Y4)	400816		815		T17		% of output type
Output 1 X Breakpoint 5 (X5)	400817		816		T17		% of parameter value
Output 1 Y Breakpoint 5 (Y5)	400818		817		T17		% of output type
Output 1 X Breakpoint 6 (X6)	400819		818		T17		% of parameter value
Output 1 Y Breakpoint 6 (Y6)	400820		819		T17		% of output type
Output 1 Average interval	400821		820		T1	0	1 period (0.02 s @50 Hz) default
						1	2 periods (0.04 s @50 Hz)
						2	4 periods (0.08 s @50 Hz)
						3	8 periods (0.16 s @50 Hz)
						4	16 periods (0.32 s @50 Hz)
						5	32 periods (0.64 s @50 Hz)
						6	64 periods (1.28 s @50 Hz)
						7	128 periods (2.56 s @50 Hz)
						8	256 periods (5.12 s @50 Hz)
Reserved	400822	400823	821				
ANALOGUE OUTPUT 2	400824	400842	823				See ANALOGUE OUTPUT 1
Reserved	400843	400844	842				
ANALOGUE OUTPUT 3	400845	400863	844				See ANALOGUE OUTPUT 1
Reserved	400864	400865	863				
ANALOGUE OUTPUT 4	400866	400884	865				See ANALOGUE OUTPUT 1
Reserved	400885	401000	884				
ALARMS							
Alarm Enable Flags 1...16					T1	Bit-1	Enable Alarm i
Reserved	401002		1001				
ALARM GROUP 1 (No. 1..8)							
Thermal function time constant	401003				T1		Minutes

Compare time delay	401004				T1		Seconds
Hysteresis	401005				T16		% of compare value, if 0 then % of nominal value
Reserved	401006	401007	1005	1006			
ALARM 1							
Alarm 1 parameter	401008		1007		T1		See OutTypes
Alarm 1 function	401009		1008		T1	Bit-1	Reserved: Store into memory (all)
						Bit-2	Store into memory (1 per minute)
						Bit-3	Activate LED
						Bit-4	Activate Alarm Output
						Bit-5	Activate Beep Output
						Bit-6	Alarm Condition > (< if 0)
						Bit-7	Use Thermal function
Alarm 1 compare value	401010		1009		T17		% of parameter value
ALARM 2	401011	401013	1010	1012			See ALARM 1
ALARM 3	401014	401016	1013	1015			See ALARM 1
ALARM 4	401017	401019	1016	1018			See ALARM 1
ALARM 5	401020	401022	1019	1021			See ALARM 1
ALARM 6	401023	401025	1022	1024			See ALARM 1
ALARM 7	401026	401028	1025	1027			See ALARM 1
ALARM 8	401029	401031	1028	1030			See ALARM 1
ALARM GROUP 2 (No. 9...16)	401032	401060	1031	1059			See ALARM GROUP 1

All other Modbus registers are a subject to change. For the latest Modbus register definitions, go to DEIF's web page www.deif.com

Data types decoding

Type	Bit mask	Description
T1		Unsigned Value (16 bit) Example: 12345 = 3039(16)
T2		Signed Value (16 bit) Example: -12345 = CFC7(16)
T3		Signed Long Value (32 bit) Example: 123456789 = 075B CD 15(16)
T4	bits # 15...14 bits # 13...00	Short Unsigned float (16 bit) Decade Exponent (Unsigned 2 bit) Binary Unsigned Value (14 bit) Example: 10000*102 = A710(16)
T5	bits # 31...24 bits # 23...00	Unsigned Measurement (32 bit) Decade Exponent (Signed 8 bit) Binary Unsigned Value (24 bit) Example: 123456*10-3 = FD01 E240(16)
T6	bits # 31...24 bits # 23...00	Signed Measurement (32 bit) Decade Exponent (Signed 8 bit) Binary Signed value (24 bit) Example: - 123456*10-3 = FDFE 1DC0(16)
T7	bits # 31...24 bits # 23...16 bits # 15...00	Power Factor (32 bit) Sign: Import/Export (00/FF) Sign: Inductive/Capacitive (00/FF) Unsigned Value (16 bit), 4 decimal places Example: 0.9876 CAP = 00FF 2694(16)
T9	bits # 31...24 bits # 23...16 bits # 15...08 bits # 07...00	Time (32 bit) 1/100s 00 - 99 (BCD) Seconds 00 - 59 (BCD) Minutes 00 - 59 (BCD) Hours 00 - 24 (BCD) Example: 15:42:03.75 = 7503 4215(16)
T10	bits # 31...24 bits # 23...16 bits # 15...00	Date (32 bit) Day of month 01 - 31 (BCD) Month of year 01 - 12 (BCD) Year (unsigned integer) 1998..4095 Example: 10, SEP 2000 = 1009 07D0(16)
T16		Unsigned Value (16 bit), 2 decimal places Example: 123.45 = 3039(16)
T17		Signed Value (16 bit), 2 decimal places Example: -123.45 = CFC7(16)
T_Str4		Text: 4 characters (2 characters for 16 bit register)
T_Str6		Text: 6 characters (2 characters for 16 bit register)
T_Str8		Text: 8 characters (2 characters for 16 bit register)
T_Str16		Text: 16 characters (2 characters for 16 bit register)
T_Str40		Text: 40 characters (2 characters for 16 bit register)
T_float	bits # 31 bits # 30..23 bits # 22..0	IEEE 754 Floating-Point Single Precision Value (32 bit) Sign Bit (1 bit) Exponent Field (8 bit) Significand (23 bit) Example: 123.45 stored as 123.45000 = 42F6 E666(16)

8. Appendix B: Calculations and equations

Calculations

Definitions of symbols

No.	Symbol	Definition
1	M_v	Sample factor
2	M_P	Average interval
3	U_f	Phase voltage (U_1 , U_2 or U_3)
4	U_{ff}	Phase-to-phase voltage (U_{12} , U_{23} or U_{31})
5	N	Total number of samples in a period
6	n	Sample number ($0 \leq n \leq N$)
7	x, y	Phase number (1, 2 or 3)
8	i_n	Current sample n
9	u_{fn}	Phase voltage sample n
10	u_{fFn}	Phase-to-phase voltage sample n
11	φ_f	Power angle between current and phase voltage f (φ_1 , φ_2 or φ_3)
12	U_c	Agreed supply voltage

Equations

Voltage

$U_f = \sqrt{\frac{\sum_{n=1}^N u_n^2}{N}}$	<p style="text-align: center;">Phase voltage</p> <p>N – 128 samples in one period (up to 65 Hz) N – 128 samples in M_v periods (above 65 Hz) Example: 400 Hz $\rightarrow N = 7$</p>
$U_{xy} = \sqrt{\frac{\sum_{n=1}^N (u_{xn} - u_{yn})^2}{N}}$	<p style="text-align: center;">Phase-to-phase voltage</p> <p>u_x, u_y – phase voltages (U_f) N – a number of samples in a period</p>

Current

$I_{RMS} = \sqrt{\frac{\sum_{n=1}^N i_n^2}{N}}$	<p style="text-align: center;">Phase current</p> <p>N – 128 samples in a period (up to 65 Hz) N – 128 samples in more periods (above 65 Hz)</p>
$I_n = \sqrt{\frac{\sum_{n=1}^N (i_{1n} + i_{2n} + i_{3n})^2}{N}}$	<p style="text-align: center;">Neutral current</p> <p>i – n sample of phase current (1, 2 or 3) N = 128 samples in a period (up to 65 Hz)</p>

Power

$P_f = \frac{1}{N} \cdot \sum_{n=1}^N (u_{f_n} \times i_{f_n})$	Active power by phases N – a number of samples in a period n – sample number ($0 \leq n \leq N$) f – phase designation
$P_t = P_1 + P_2 + P_3$	Total active power t – total power 1, 2, 3 – phase designation
$\text{Sign}Q_f(\varphi)$ $\varphi \in [0^\circ - 180^\circ] \Rightarrow \text{Sign}Q_f(\varphi) = +1$ $\varphi \in [180^\circ - 360^\circ] \Rightarrow \text{Sign}Q_f(\varphi) = -1$	Reactive power sign Q_f – reactive power (by phases) φ – power angle
$S_f = U_f \times I_f$	Apparent power by phases U_f – phase voltage I_f – phase current
$S_t = S_1 + S_2 + S_3$	Total apparent power S_f – apparent power by phases
$Q_f = \text{Sign}Q_f(\varphi) \times \sqrt{S_f^2 - P_f^2}$	Reactive power by phases (standard) S_f – apparent power by phases P_f – active power by phases
$Q_f = \frac{1}{N} \cdot \sum_{n=1}^N (u_{f_n} \times i_{f_{[n+N/4]}})$	Reactive power by phases (delayed current method) N – a number of samples in a period n – sample number ($0 \leq n \leq N$) f – phase designation
$Q_t = Q_1 + Q_2 + Q_3$	Total reactive power Q_f – reactive power by phases
$\varphi_s = \arctan 2(P_t, Q_t)$ $\varphi_s = [-180^\circ, 179,99^\circ]$	Total power angle P_t – total active power S_t – total apparent power
$\text{PF} = \frac{P}{S}$	Distortion factor P – total active power S – total apparent power
$\text{PF}_f = \frac{P_f}{S_f}$	Distortion factor P_f – phase active power S_f – phase apparent power

THD

$I_f \text{ THD}(\%) = \frac{\sqrt{\sum_{n=2}^{63} I_n^2}}{I_1} \cdot 100$	Current THD I_1 – value of first harmonic n – number of harmonic
$U_f \text{ THD}(\%) = \frac{\sqrt{\sum_{n=2}^{63} U_n^2}}{U_1} \cdot 100$	Phase voltage THD U_1 – value of first harmonic n – number of harmonic
$U_{ff} \text{ THD}(\%) = \frac{\sqrt{\sum_{n=2}^{63} U_n^2}}{U_1} \cdot 100$	Phase-to-phase voltage THD U_1 – value of first harmonic n – number of harmonic

Energy

$\text{Price in tariff} = \text{Price} \cdot 10^{\text{Tariff price exponent}}$	Total exponent of tariff price and energy price in all tariffs
---------------------------------------------------------------------------------	----------------------------------------------------------------

DEIF A/S reserves the right to change any of the above.