

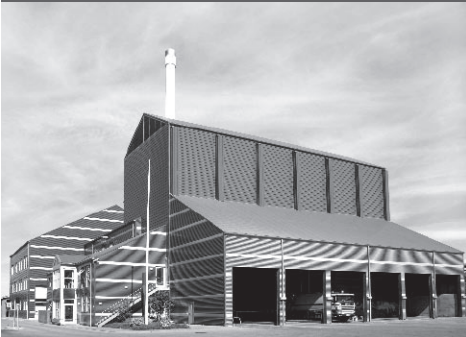

-power in control



QUICK START GUIDE



Generator Paralleling Controller, GPC-3 Generator Protection Unit, GPU-3/GPU-3 Hydro Paralleling and Protection Unit, PPU-3

- What's in the delivery?
- Getting started
- The first steps
- PC utility software



DEIF A/S · Frisenborgvej 33 · DK-7800 Skive
Tel.: +45 9614 9614 · Fax: +45 9614 9615
info@deif.com · www.deif.com

Document no.: 4189340603C
SW version: 3.0X.X or later

1. General information

1.1. Warnings, legal information and safety.....	3
1.1.1. Warnings and notes	3
1.1.2. Legal information and disclaimer	3
1.1.3. Safety issues	3
1.1.4. Electrostatic discharge awareness	3
1.1.5. Factory settings	4
1.2. About the Quick Start Guide.....	4
1.2.1. General purpose.....	4
1.2.2. Intended users.....	4
1.2.3. Contents and overall structure	4

2. What's in the delivery?

2.1. Standard delivery.....	5
2.2. Optional delivery.....	6

3. Getting started

3.1. Connecting the devices.....	8
3.1.1. Connecting the display with the main unit.....	8
3.1.2. Connecting the power supply to the main unit.....	9
3.1.3. Connecting the additional operator panel, AOP-1 (optional).....	9
3.1.4. Connecting the additional operator panel, AOP-2 (optional).....	10
3.2. Wiring.....	11
3.2.1. Basic wiring for GPU-3 and GPU-3 Hydro.....	11
3.2.2. Basic wiring for GPC-3 and PPU-3.....	13

4. The first steps

4.1. Basic AC values.....	15
4.2. Getting started with the DEIF utility software (USW).....	17
4.2.1. Downloading the software.....	17
4.2.2. Installation of USB drivers.....	17
4.2.3. Getting connected.....	18
4.2.4. Read parameters from the device.....	20
4.2.5. Basic configuration of a device using the utility software.....	20

5. Configuring the speed governor and AVR outputs

5.1. Settings for speed governor and AVR control.....	22
---	----

1. General information

1.1 Warnings, legal information and safety

1.1.1 Warnings and notes

Throughout this document, a number of warnings and notes with helpful user information will be presented. To ensure that these are noticed, they will be highlighted as follows in order to separate them from the general text.

Warnings



Warnings indicate a potentially dangerous situation, which could result in death, personal injury or damaged equipment, if certain guidelines are not followed.

Notes



Notes provide general information, which will be helpful for the reader to bear in mind.

1.1.2 Legal information and disclaimer

DEIF takes no responsibility for installation or operation of the generator set. If there is any doubt about how to install or operate the engine/generator controlled by the Multi-line 2 unit, the company responsible for the installation or the operation of the set must be contacted.



The Multi-line 2 unit is not to be opened by unauthorised personnel. If opened anyway, the warranty will be lost.

Disclaimer

DEIF A/S reserves the right to change any of the contents of this document without prior notice.

The English version of this document always contains the most recent and up-to-date information about the product. DEIF does not take responsibility for the accuracy of translations, and translations might not be updated at the same time as the English document. If there is a discrepancy, the English version prevails.

1.1.3 Safety issues

Installing and operating the Multi-line 2 unit may imply work with dangerous currents and voltages. Therefore, the installation should only be carried out by authorised personnel who understand the risks involved in working with live electrical equipment.



Be aware of the hazardous live currents and voltages. Do not touch any AC measurement inputs as this could lead to injury or death.

1.1.4 Electrostatic discharge awareness

Sufficient care must be taken to protect the terminal against static discharges during the installation. Once the unit is installed and connected, these precautions are no longer necessary.

1.1.5 Factory settings

The Multi-line 2 unit is delivered from factory with certain factory settings. These are based on average values and are not necessarily the correct settings for matching the engine/generator set in question. Precautions must be taken to check the settings before running the engine/generator set.

1.2 About the Quick Start Guide

1.2.1 General purpose

This Quick Start Guide mainly includes general product information, mounting instructions and wiring descriptions.

The general purpose of this document is to help the user with the first steps of installing and using the Multi-line 2 system.



Please make sure that you also read the Installation Instructions before starting to work with the Multi-line 2 unit and the genset to be controlled. Failure to do this could result in human injury or damage to the equipment.

1.2.2 Intended users

This Quick Start Guide is mainly intended for the panel builder in charge. On the basis of this document, the panel builder designer will give the electrician the information he needs in order to get started with the installation. For detailed electrical drawings, please see the Installation Instructions.

1.2.3 Contents and overall structure

This document is divided into chapters, and in order to make the structure simple and easy to use, each chapter will begin from the top of a new page.

2. What's in the delivery?

2.1 Standard delivery

The main unit

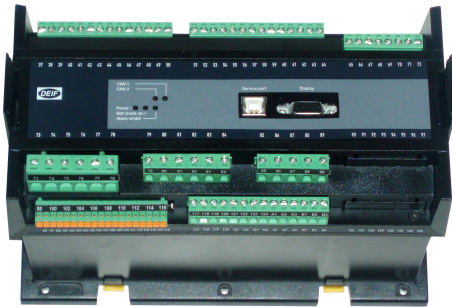

Standard display unit, DU-2



Layout is option-dependent

Display cable, 3 m



Installation instructions

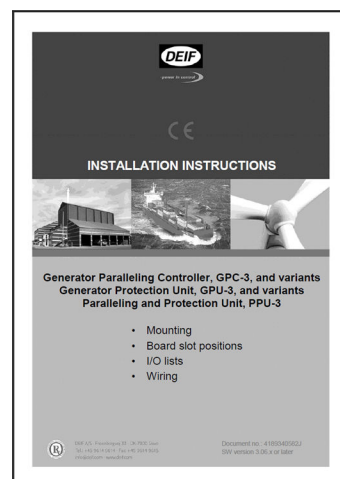

2.2 Optional delivery

Display cable with plugs, 6 m (option J2)



PC cable for option N programming - Ethernet cable crossed (option J4)



Display cable with plugs, 1 m (option J6)



PC cable for utility software (option J7)



Additional standard display, DU-2 (option X2)



Display unit, DU-2



DC/DC converter and 2 × CAN bus cable 3 m

Additional operator panel, AOP-1 (option X3)

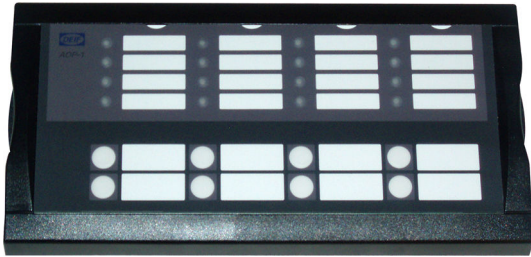

AOP-1



0.5 m cable

Additional operator panel, AOP-2 (option X4)

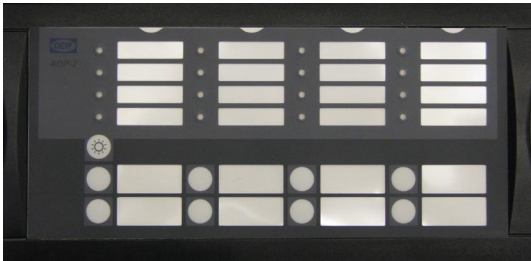

AOP-2



DC/DC converter and 2 x CAN bus cable 3 m

3. Getting started

3.1 Connecting the devices

3.1.1 Connecting the display with the main unit

Connect the SUB-D display cable to the main unit and the display unit as shown in the picture below.

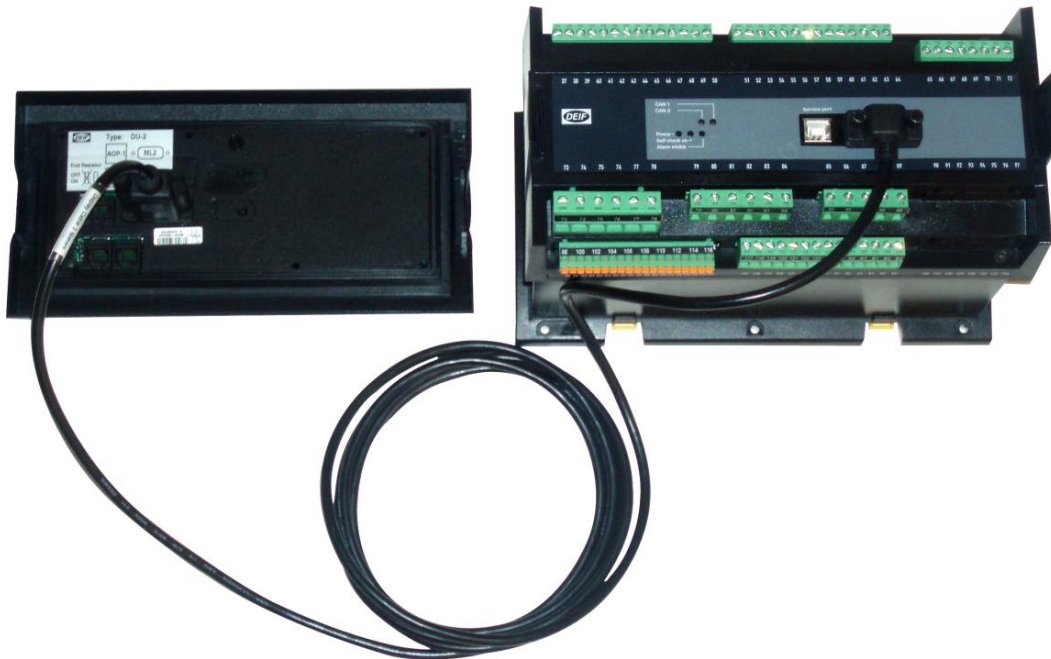

No use of tools or brute force when tightening finger-screws on display cable.

3.1.2 Connecting the power supply to the main unit

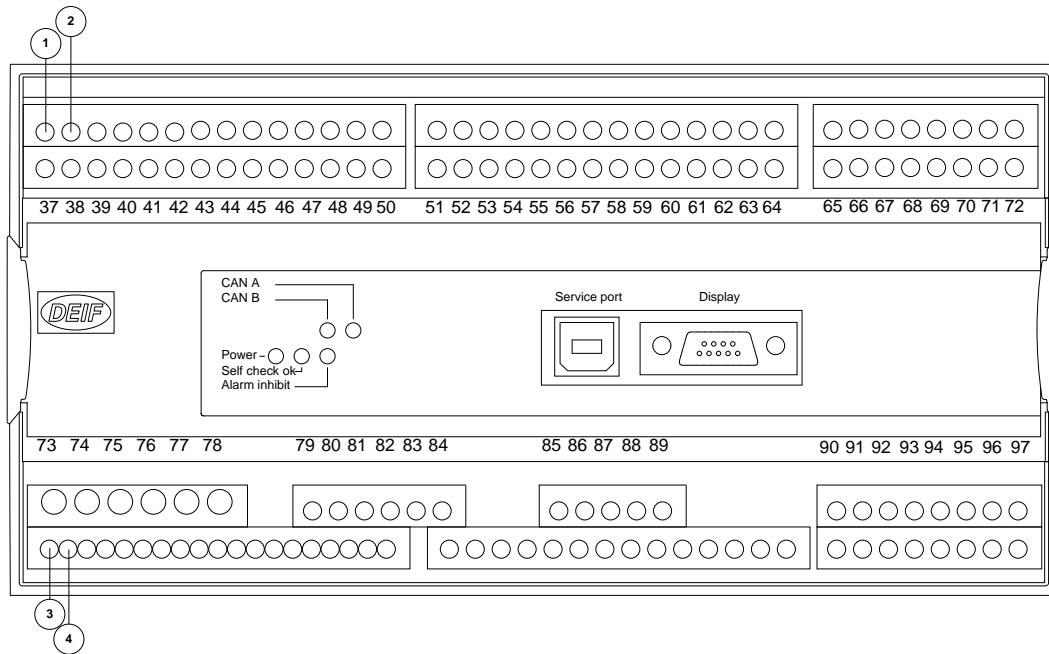

1. Terminal 1: +24 V DC
2. Terminal 2: 0 V DC
3. **Option M4** - terminal 98: +24 V DC
4. **Option M4** - terminal 99: 0 V DC

3.1.3 Connecting the additional operator panel, AOP-1 (optional)

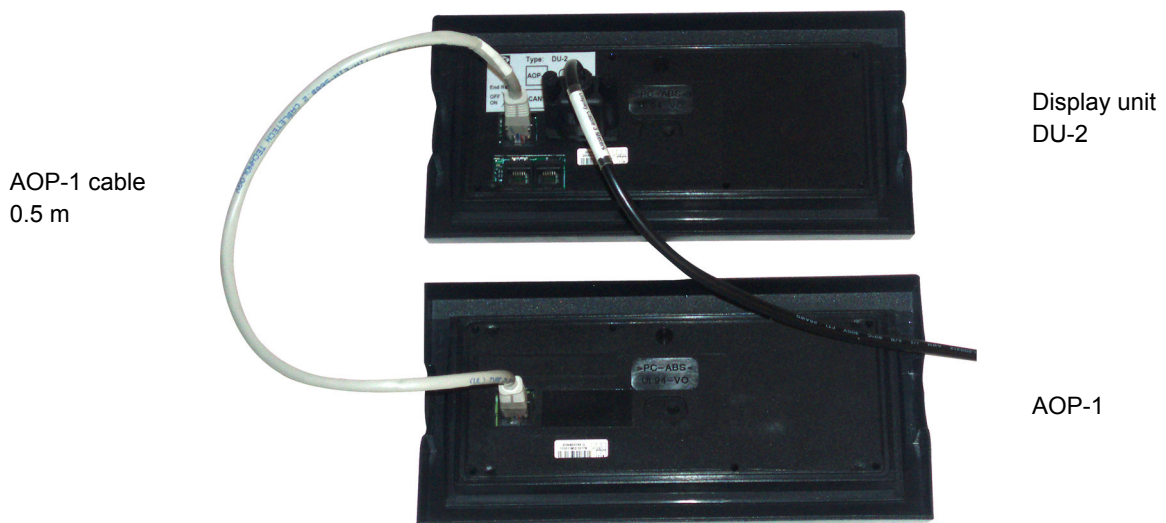

3.1.4 Connecting the additional operator panel, AOP-2 (optional)

The CAN cable for the CAN bus communication between the display unit of main unit no. 1 and the AOP-2 must be connected to the CAN port (CAN 2) of the display unit (DU-2) and the CAN port (CAN 1) of the AOP-2 as shown in the drawing below.

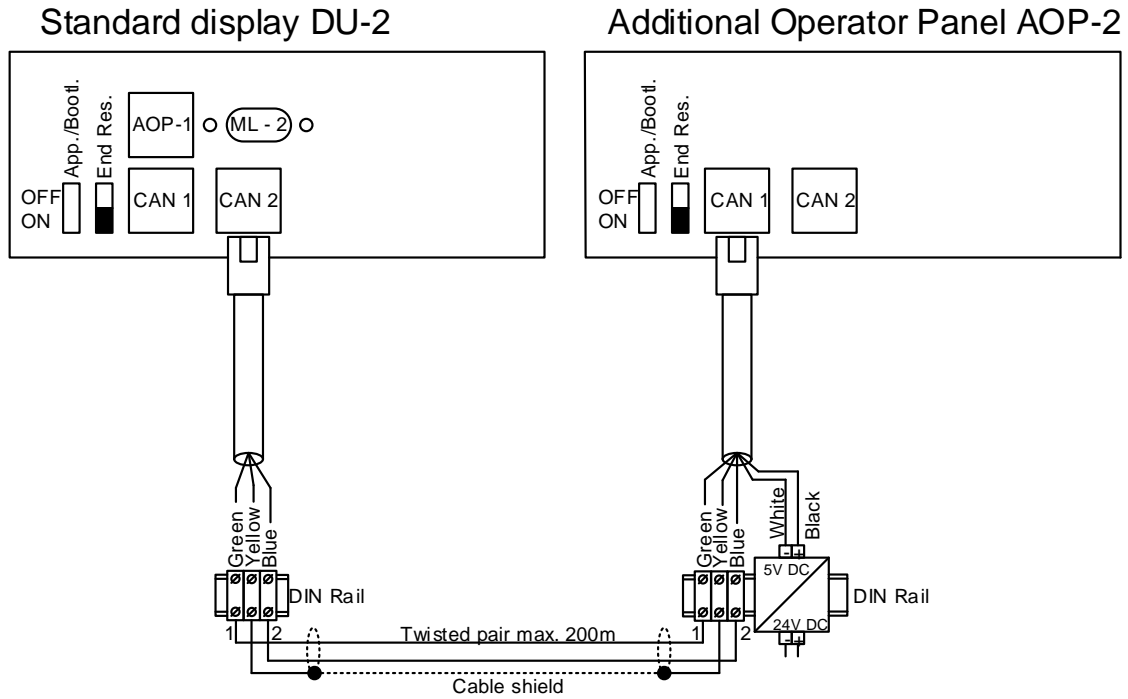

The AOP-2 can be placed up to 200 m from the main display. The AOP-2 requires a separate power supply unit, while the display receives the power supply through the display cable from the main unit.

i For further information about the installation of multiple displays and AOP-2s, see the document "Description of Option X".

3.2 Wiring

3.2.1 Basic wiring for GPU-3 and GPU-3 Hydro

AC wiring

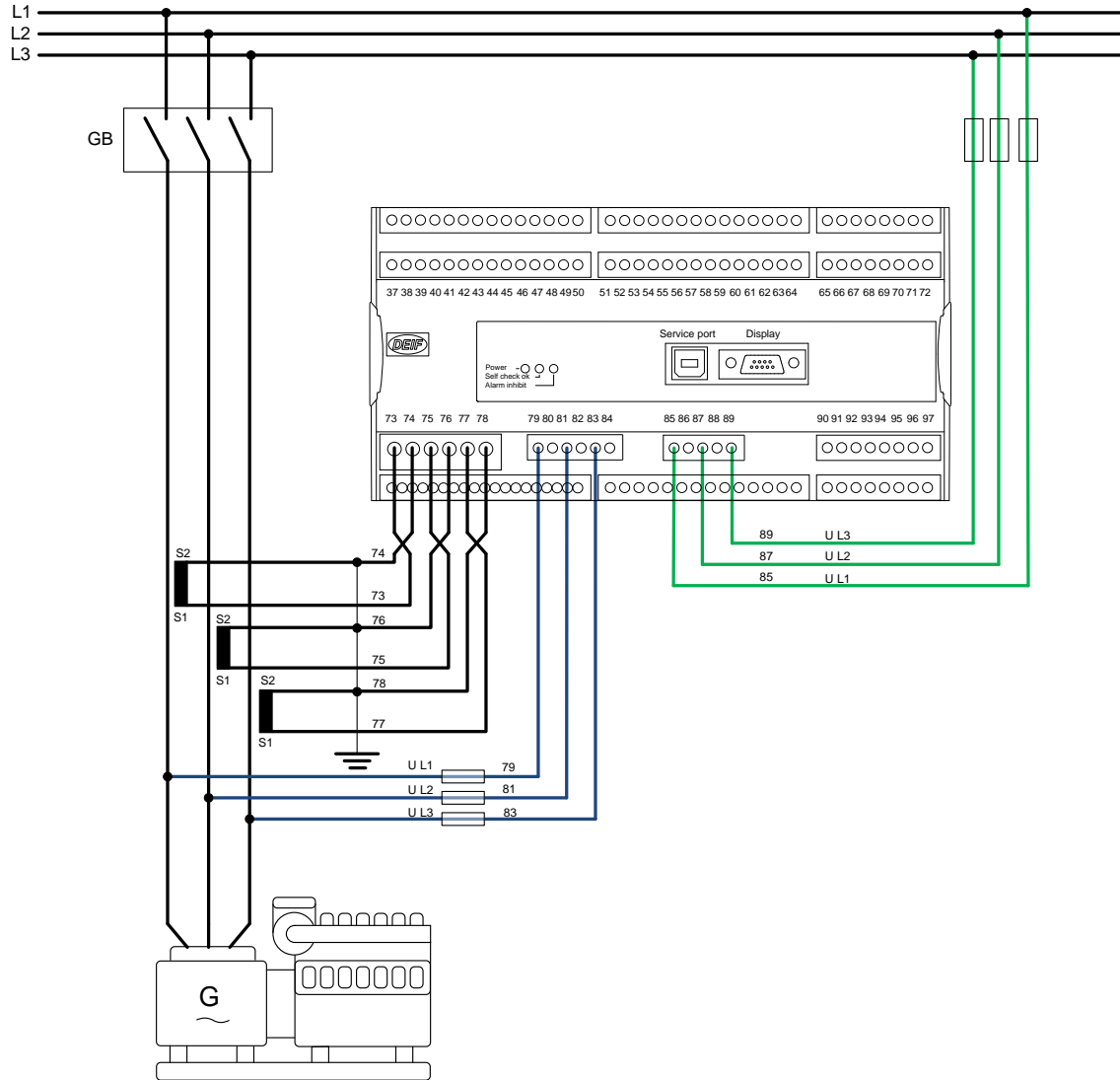

DC wiring

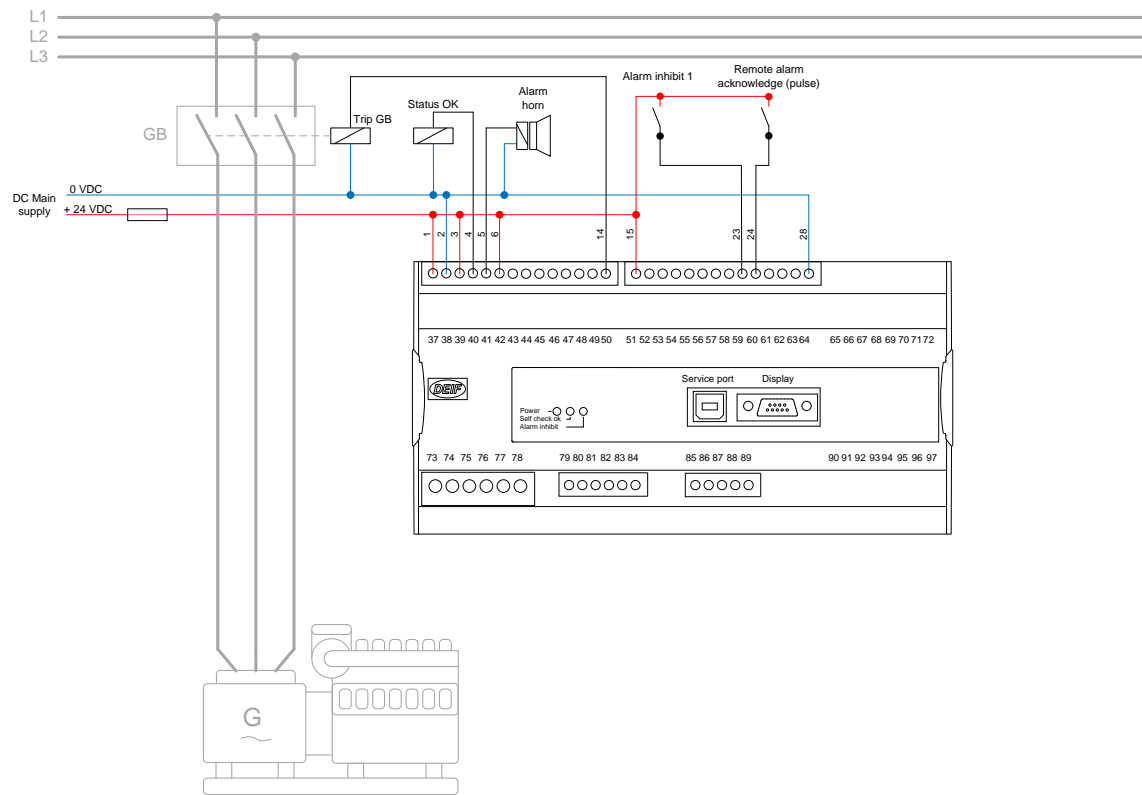

3.2.2 Basic wiring for GPC-3 and PPU-3

AC wiring

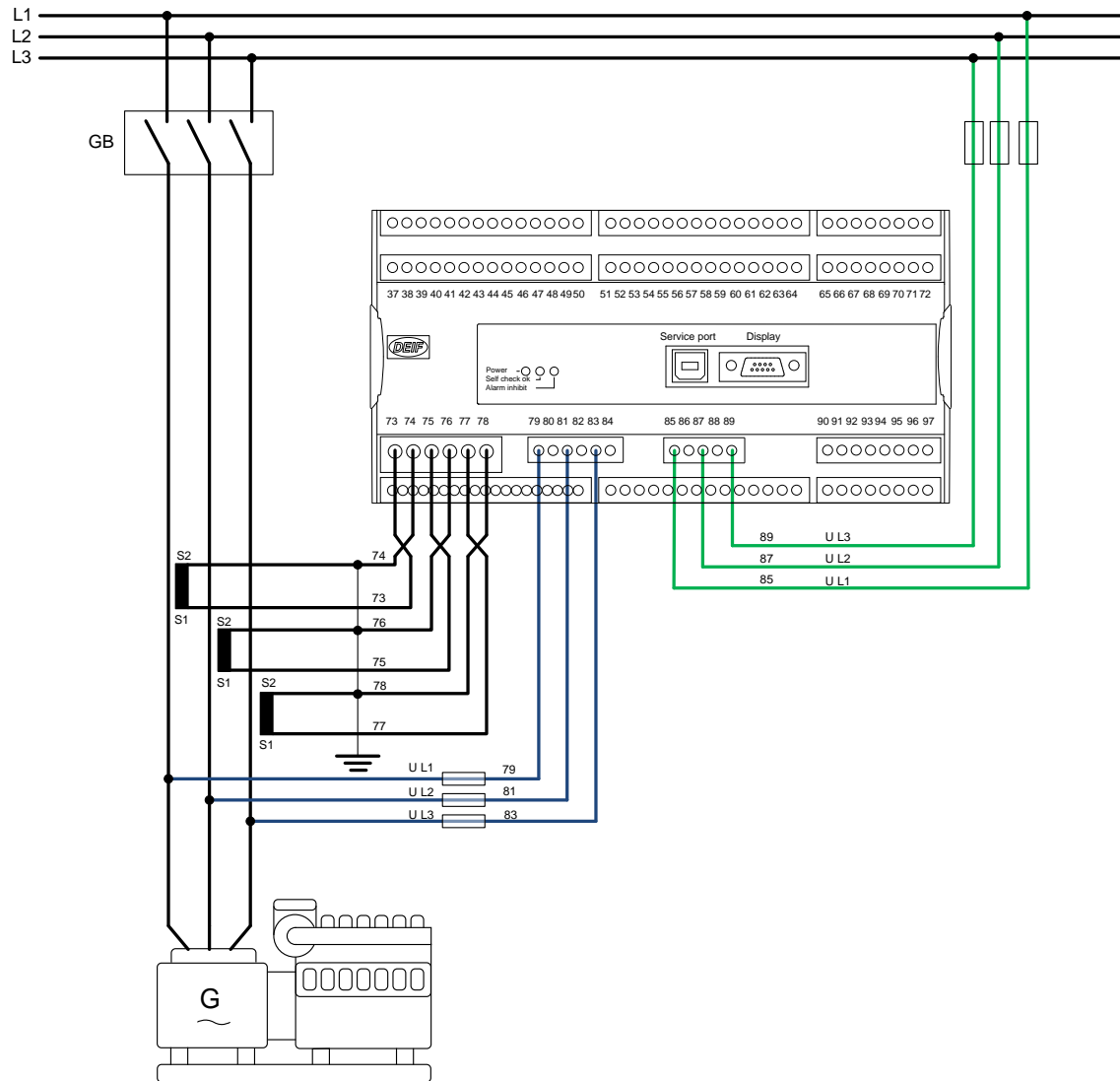

For further information, see the document "Installation Instructions".

DC wiring

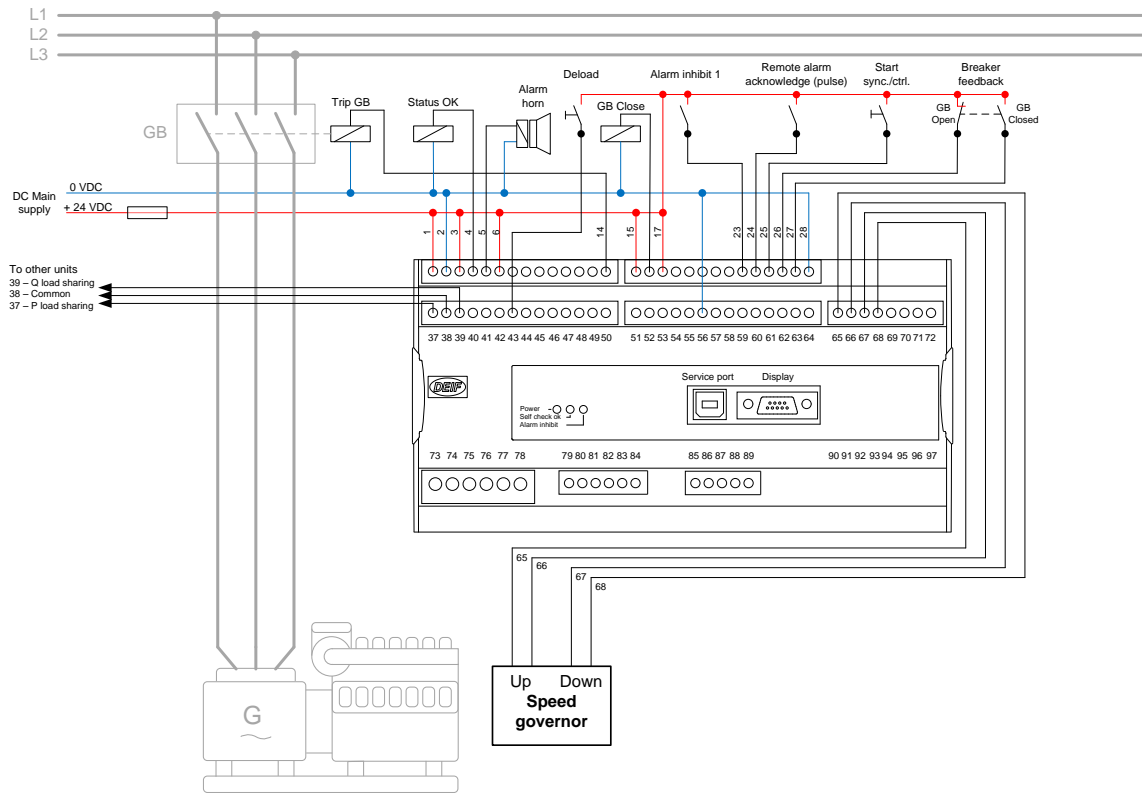

4. The first steps

4.1 Basic AC values

This chapter guides you through the most essential parameters which must be adjusted before you can start using the unit.

The set points can either be adjusted from the display unit or by using the DEIF utility software. The following examples will show how to adjust the parameters from the display unit.

All settings are reached by placing the cursor under SETUP (in the main page) and pressing ENTER.

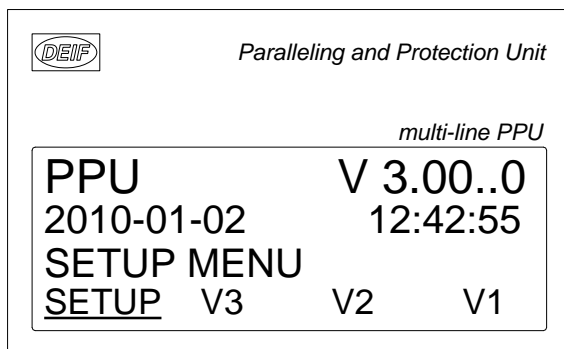

Place the cursor under SYST and press ENTER.

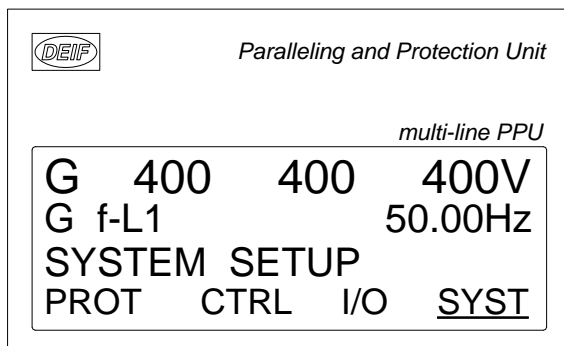

Place the cursor under GEN and press ENTER.

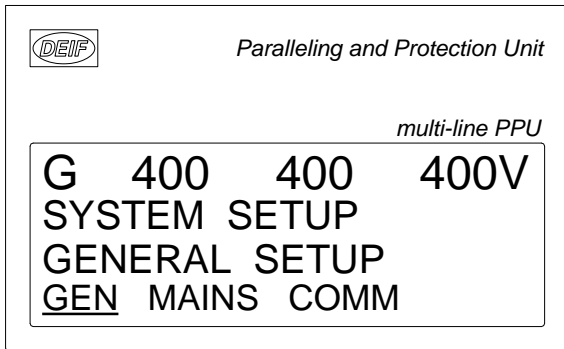

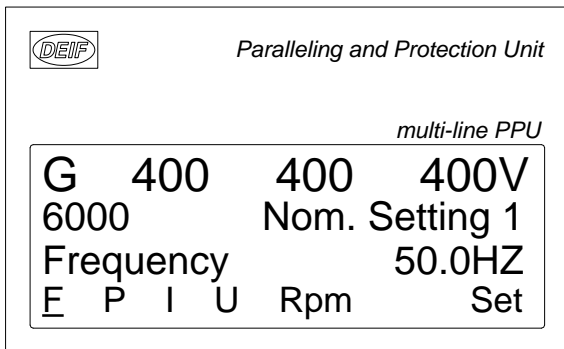

Place the cursor under the setting you require and press ENTER.



Generator nominal settings 1

No.	Setting	Min. Max.	Factory setting	Notes	Ref.	Description
6000 nominal settings 1						
6001	Nom. settings 1	Frequency	48.0 Hz 62.0 Hz	50.0 Hz	Designer's Reference Handbook	The selection of nominal settings to be used is set in 6006. A binary input or selection in M-Logic can also be used. The range of nom. voltage and nom. power depends on the selected range in "9030 Scaling".
6002	Nom. settings 1	Power	10 kW 20000 kW	480 kW		
6003	Nom. settings 1	Current	0 A 9000 A	867 A		
6004	Nom. settings 1	Voltage	100 V 25000 V	400 V		
6005	Nom. settings 1	RPM	100 RMP 4000 RPM	1500 RPM		
6006	Nom. settings 1	Set	1 4	1		

To adjust the transformer settings, use the  or  push-button to get to the transformer page.

VT and CT settings

No.	Setting		Min. Max.	Factory setting	Notes	Ref.	Description
6040 G transformer							
6041	G trans- former	U primary	100 V 25000 V	400 V		Designer's Reference Handbook	If no voltage transformer is present, the primary and secondary side val- ues are set to generator nominal value.
6042	G trans- former	U secon- dary	100 V 690 V	400 V			
6043	G trans- former	I primary	5 A 9000 A	1000 A			
6044	G trans- former	I secon- dary	1 A 5 A	5 A			
6050 Busbar settings							
6051	BB set- tings	U primary	100 V 25000 V	400 V		Designer's Reference Handbook	If no voltage transformer is present, the primary and secondary side val- ues are set to generator nominal value.
6052	BB set- tings	U secon- dary	100 V 690 V	400 V			
6053	BB set- tings	U BB nom.	100 V 25000 V	400 V			

4.2 Getting started with the DEIF utility software (USW)

4.2.1 Downloading the software

1. Go to www.deif.com
2. Select Software in the top menu bar
3. Scroll to the Software downloads list
4. Select Multi-line 2 Utility Software v.3.x in the list
5. Fill in your email address and click "Submit"

You will then receive an email with a link. Click the link and follow the instructions.

The USW is now installed on your computer.

4.2.2 Installation of USB drivers

On Windows Vista machines, the USB drivers are installed automatically.

This is the procedure on Windows XP machines:

When you connect the DEIF product, Windows XP will launch two "Hardware Wizards". Two drivers are installed, so please let Windows execute both "Found new Hardware Wizard"s.

We recommend letting the Hardware Wizard install the software automatically by choosing the "Recommended" option. If the "Advanced" option is chosen, the needed files are available from the USW3 installation folder (default: C:\Program Files\DEIF\USW3\ in the "USB driver files/source Preinstaller" folder.

Select "Continue Anyway" if a "Hardware Installation" warning (see screenshot below) appears during the installation.



4.2.3 Getting connected

Connect the service port to the USB on the computer (option J7 or option J3).

Click the Utility Software 3 icon on the desktop or in the Windows Start menu.



Utility Software 3.lnk

Desktop icon:



Quick launch and Start menu icon:

The below window appears.



Open the application settings by clicking this icon.



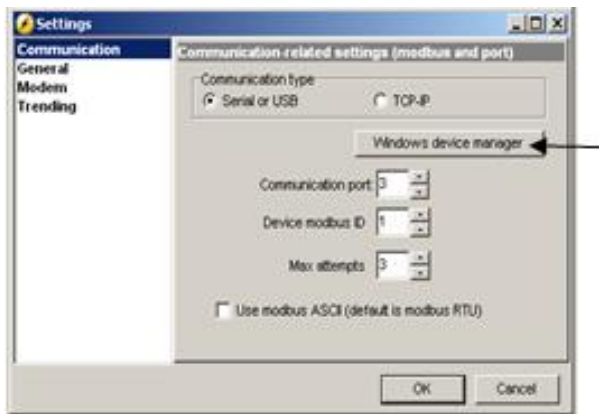

Open "Windows device manager".

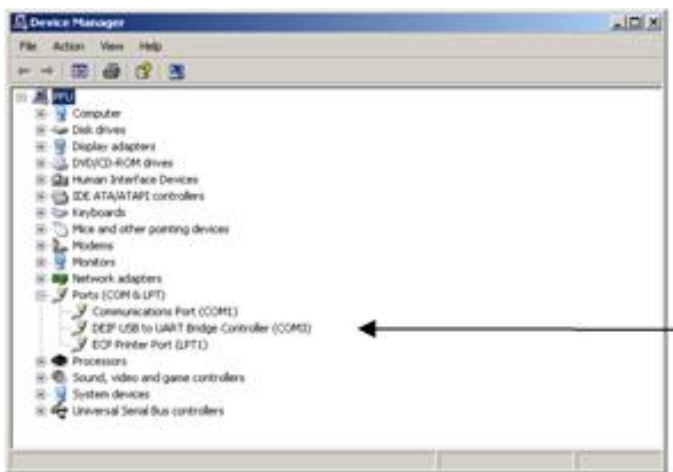

Check the COM port used for communication, and make sure the settings correspond to the application settings.



Click the "Connect" icon.



You are now online with the unit.

4.2.4 Read parameters from the device

Open the "Parameters" list.



Click the "Read parameters from the device" icon.



After retrieving all the parameters, the device is ready to be configured.

4.2.5 Basic configuration of a device using the utility software

When the parameters have been uploaded, the options below will be available.

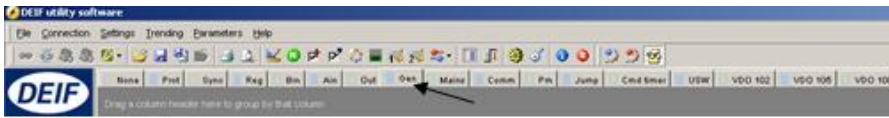

Click the "Gen" tab.



None	Print	Sync	Reg	Bin	Alm	Out	Gen	Mainc	Comm	Pin	Jump	Cmd timer	USW	VDD 102	VDD 106	VDD 108
Category	Channel	Text	Address	Value	Unit	Timer	OutputA	OutputB	Enabled	High alarm	Level	Customer				
Gen	6001	Nom.P	1	400	50	Hz	N/A	N/A	<input type="checkbox"/>			Customer				
Gen	6003	Nom.P	1	400	400	WV	N/A	N/A	<input type="checkbox"/>			Customer				
Gen	6003	Nom.U	1	400	807	A	N/A	N/A	<input type="checkbox"/>			Customer				
Gen	6004	Nom.U	1	410	400	V	N/A	N/A	<input type="checkbox"/>			Customer				
Gen	6005	Nom.rpm	1	411	1500	RFM	N/A	N/A	<input type="checkbox"/>			Customer				
Gen	6006	Enable nom. set		412	0		N/A	N/A	<input type="checkbox"/>			Customer				
Gen	6011	Nom.P	2	413	50	Hz	N/A	N/A	<input type="checkbox"/>			Customer				
Gen	6012	Nom.P	2	414	230	WV	N/A	N/A	<input type="checkbox"/>			Customer				
Gen	6013	Nom.I	2	415	345	A	N/A	N/A	<input type="checkbox"/>			Customer				
Gen	6014	Nom.U	2	416	480	V	N/A	N/A	<input type="checkbox"/>			Customer				
Gen	6015	Nom.rpm	2	417	1500	RFM	N/A	N/A	<input type="checkbox"/>			Customer				
Gen	6021	Nom.P	3	418	60	Hz	N/A	N/A	<input type="checkbox"/>			Customer				
Gen	6022	Nom.P	3	419	230	WV	N/A	N/A	<input type="checkbox"/>			Customer				
Gen	6023	Nom.I	3	420	345	A	N/A	N/A	<input type="checkbox"/>			Customer				
Gen	6024	Nom.U	3	421	480	V	N/A	N/A	<input type="checkbox"/>			Customer				

The parameters can be configured as follows:

Click a parameter and the dialogue box below will appear.

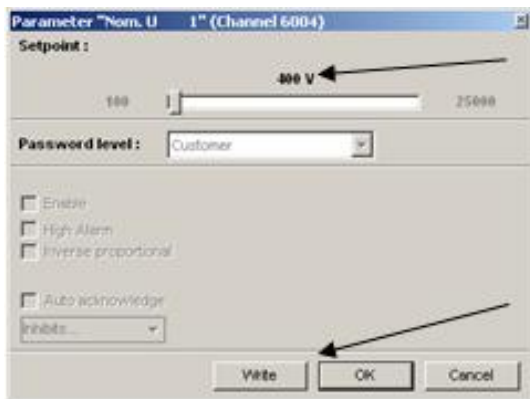

Click this or use the bar to adjust the set point, then click "Write" and "OK".

The parameter set point has now been changed and downloaded to the device.



For further information, see the "General Guidelines for Commissioning".

5. Configuring the speed governor and AVR outputs

5.1 Settings for speed governor and AVR control

Dependent on the hardware configuration, relays or analogue outputs can be used for speed governor and AVR control.

The settings used for this are the following:

No.	Setting	Min. Max.	Factory setting	Notes	Ref.	Description
2600 Relay control						
2601	Relay control	GOV ON time	10 ms 6500 ms	500 ms	Designer's Reference Handbook GPU: Option G2	This menu is only available if "Relay" is selected in menu 2781. Normally used: Relay 65 for increase and relay 67 for decrease.
2602	Relay control	GOV period time	50 ms 32500 ms	2500 ms		
2603	Relay control	Increase relay	Not used Option-dep.	Relay 65		
2604	Relay control	Decrease relay	Not used Option-dep.	Relay 67		
2720 Relay control (AVR)						
2721	Relay control	AVR ON time	10 ms 3000 ms	100 ms	Option: AVR control (D1)	Relay outputs for voltage/var/power factor control. This menu is only available if "Relay" is selected in menu 2782. Normally used: Relay 69 for increase and relay 71 for decrease
2722	Relay control	AVR per time	50 ms 1500 ms	500 ms		
2723	Relay control	U increase	Not used Option-dep.	Relay 69		
2724	Relay control	U decrease	Not used Option-dep.	Relay 71		
2780 Regulator output						
2781	Reg. output	GOV	Relay EIC	Relay	Designer's Reference Handbook GPU: Option G2	Selection of the speed output: Relay, analogue or engine interface communication. Analogue and EIC are option-dependent.

No.	Setting		Min. Max.	Factory setting	Notes	Ref.	Description
2782	Reg. output	AVR	Relay Analogue	Relay		Option: AVR control (D1)	Generator voltage control based on relay or analogue output signals. Analogue selection is only available if option E1, E2, EF2, EF4 or F2 is present.
5980 Governor output							
5981	Governor output	Output A	Disabled AO66 AO71	Disa- bled		Option E and F	Normally used: Analogue output 66
5990 AVR output							
5991	AVR out- put	Output A	Disabled AO66 AO71	Disa- bled		Option D	Normally used: Analogue output 71



AVR control requires option D1.



Analogue outputs require option E1, E2, EF2, EF4 or EF5.



For further information, see the document "General Guidelines for Commissioning".

For further information, check the following documents:

GPC-3 Designer's Reference Handbook	Document no. 4189340587
GPU-3 Designer's Reference Handbook	Document no. 4189340584
GPU-3 Hydro Designer's Reference Handbook	Document no. 4189340588
PPU-3 Designer's Reference Handbook	Document no. 4189340583
GPC-3/GPU-3/GPU-3 Hydro/PPU-3 Installation Instructions	Document no. 4189340582
GPC-3/GPU-3/GPU-3 Hydro/PPU-3 Operator's Manual	Document no. 4189340579